

THE ART OF

WARHAMMER
40,000

SPACE MARINE

Warhammer 40,000 boasts one of the richest science-fiction settings ever conceived. Bringing this universe to life through the lens of the action-blockbuster video game has been an incredibly fulfilling, if challenging, experience. Challenging, not because the universe doesn't lend itself to this kind of treatment; challenging, because the opposite is true.

Space Marine has been an exercise in creative focus. Focus on the elements that would allow us to present a faithful translation, with a presentation full of epic spectacle that – we hope – will do this prodigious universe justice for the millions of its faithful fans. Focus on elements that draw a whole new audience into discovering how truly compelling a world this is.

We hope that whether you are new to Warhammer 40,000, or one of its army of devoted fans, you will discover something in Captain Titus' trials on Forge World Graia that resonates with you, not only as a video game, but as an epic adventure and escapist fantasy that brings you enjoyment for years to come.

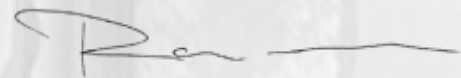

Raphael van Lierop
Game Director
May 2nd, 2011
Vancouver, Canada



We aimed to capture the epic scale and nature of the Forge World that Space Marine takes place on. This is an entire planet dedicated to creating weapons and machines of mass destruction, so everything is considered on a massive scale. It was very important to us that this was framed for the player throughout the game in a digestible manner.

In a universe that knows only war comes a certain level of carnage and destruction, none of which was taken lightly in Space Marine. We bombed, collapsed and ripped the Forge World to shreds, some of this prior to the players arrival, some during game play. We also made ample opportunity to show off the splendour of the intact areas of the world; unimaginably large weapons and factory sets to dark experimental labs – all crafted with a gothic architectural aesthetic which gives us the opportunity to show off very unique game spaces.

A Forge World is a place choked with the haze of battle and industry, which gave us a compelling backdrop to play with. The variety of spaces offer a range of nice colour palettes via atmosphere and lighting - Battlefields, Titan factory interiors, Hab Blocks to Sewers with varying layers of Ork decor to draw the player further into the game and into the 40K universe.

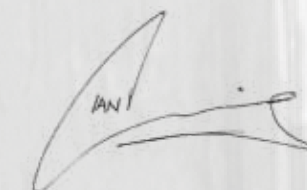

Ian Cumming,
Art Director
May 2nd, 2011
Vancouver, Canada

THE IMPERIUM OF HUMANITY

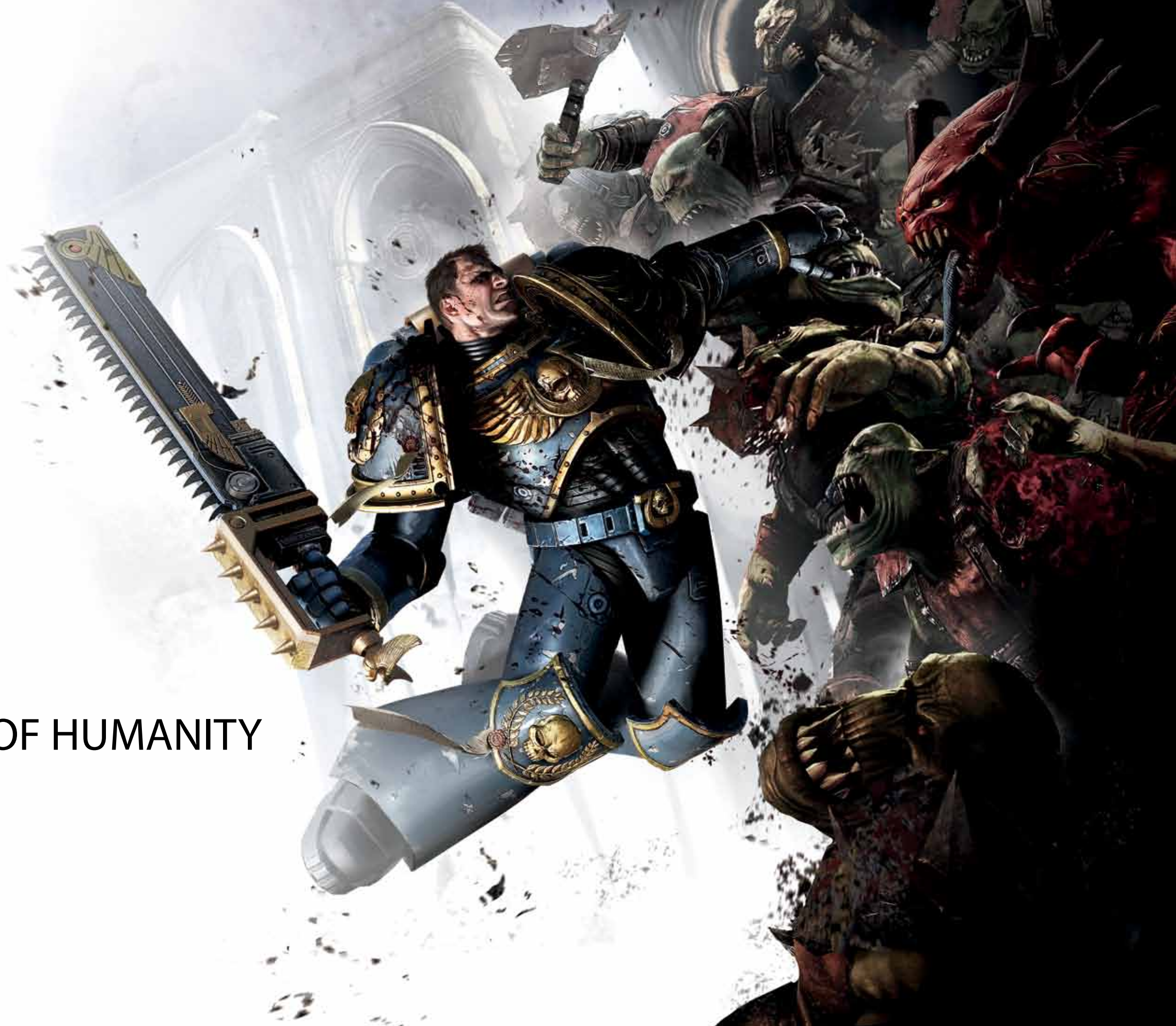



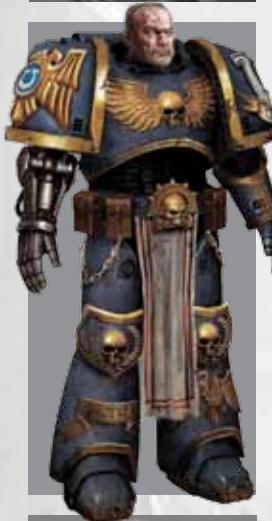
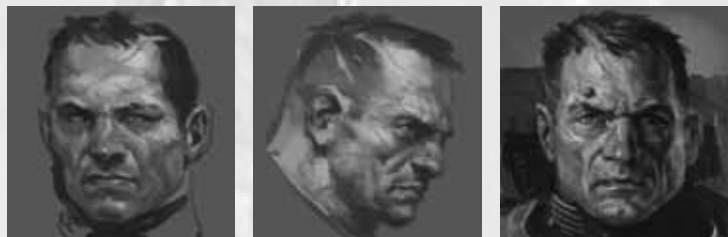



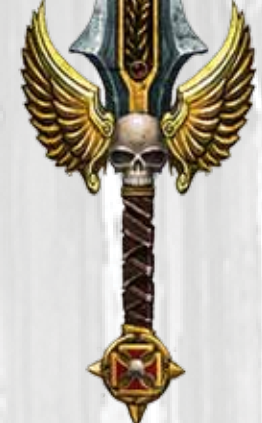

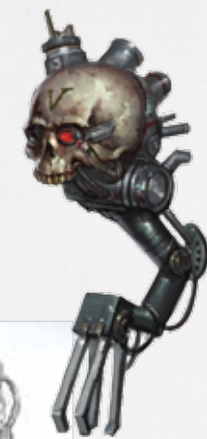
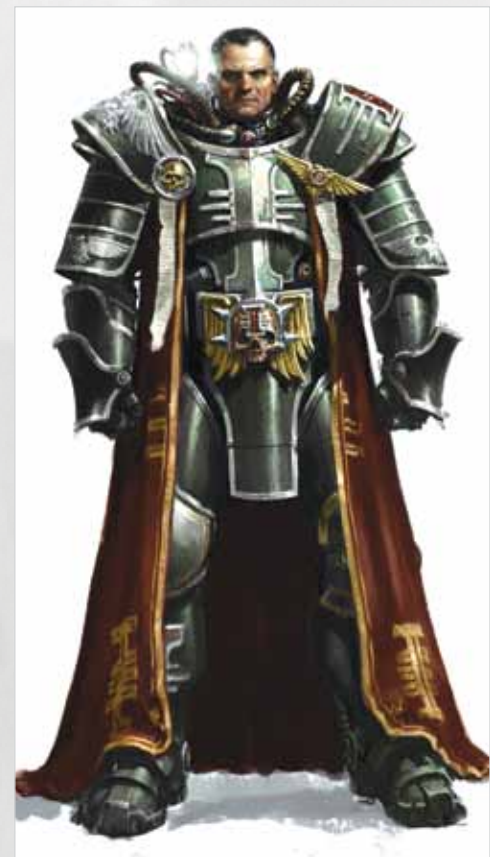
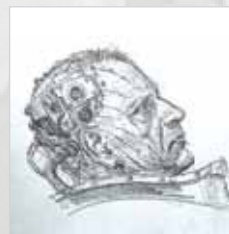
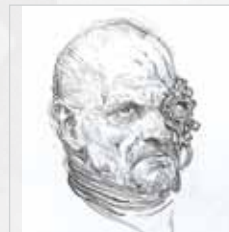







FORGE WORLD GRAIA





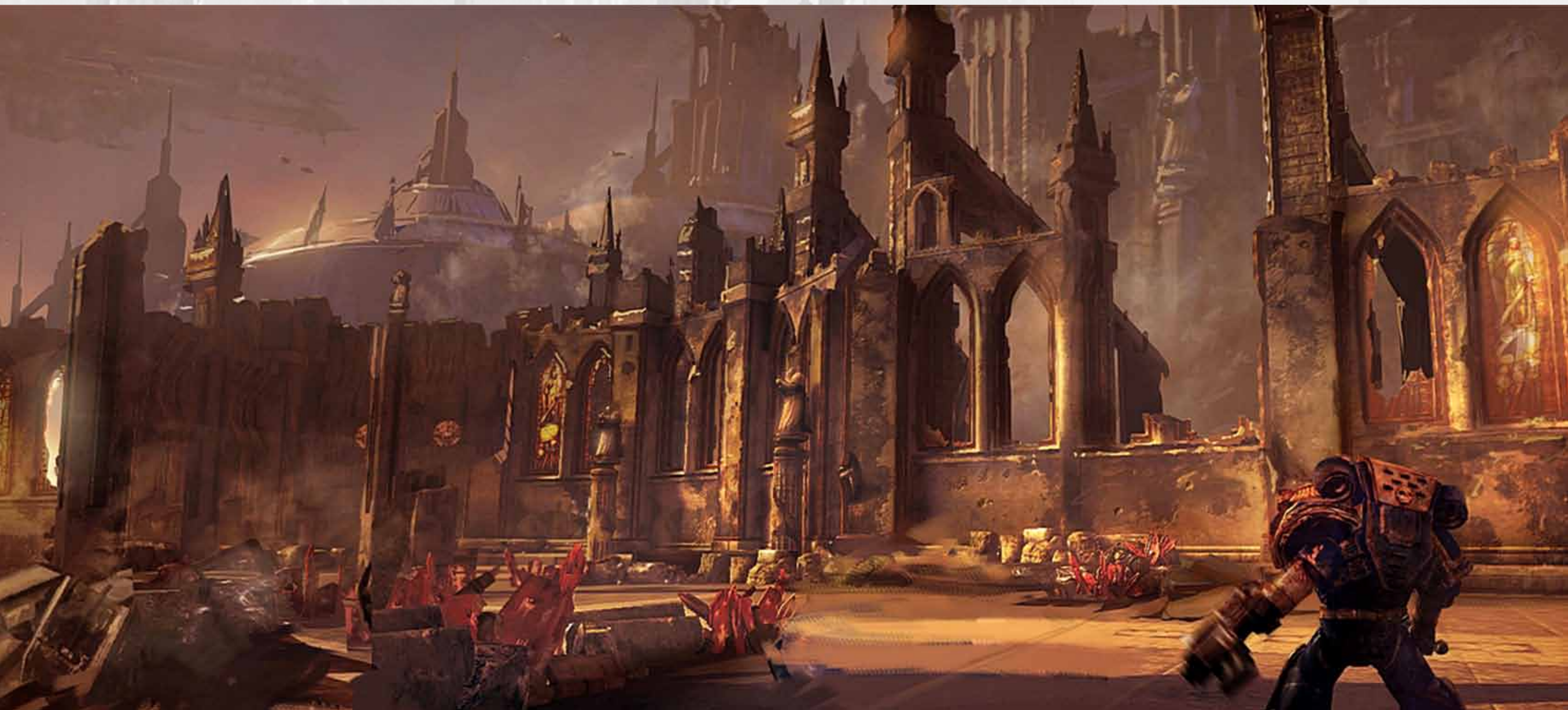

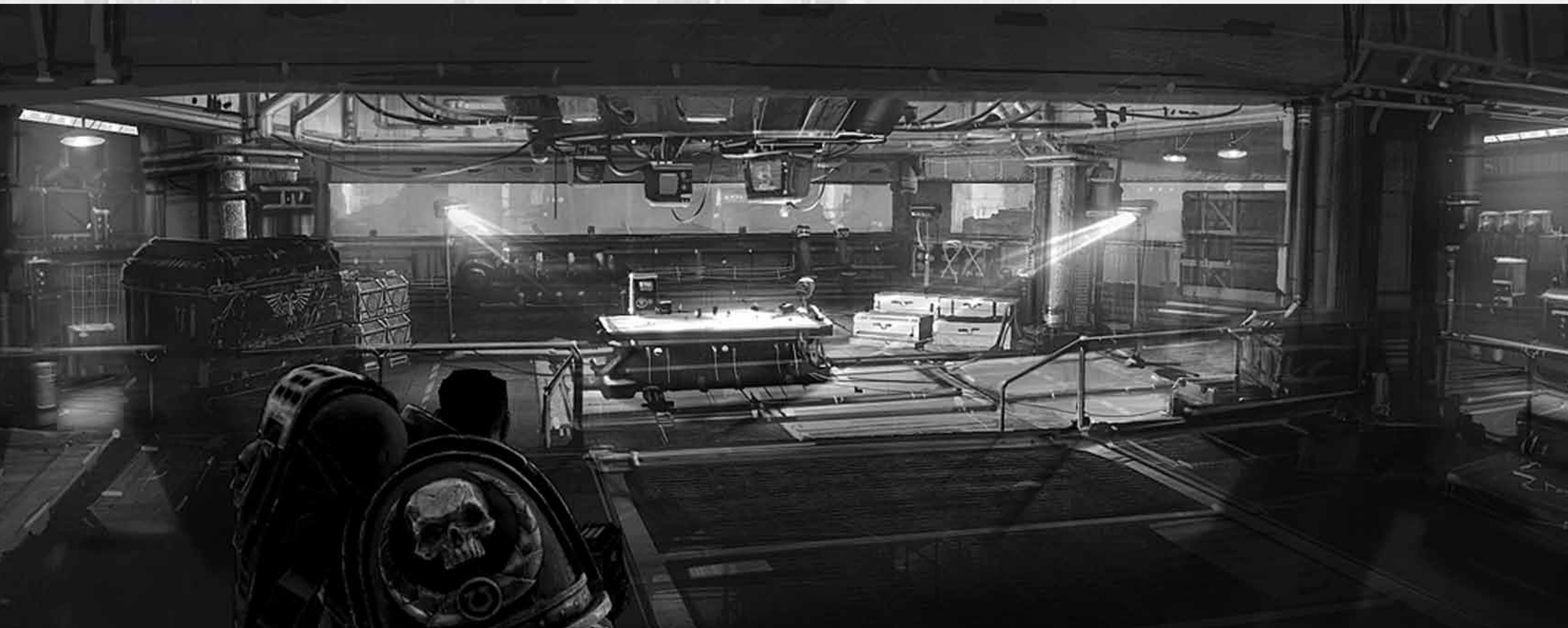

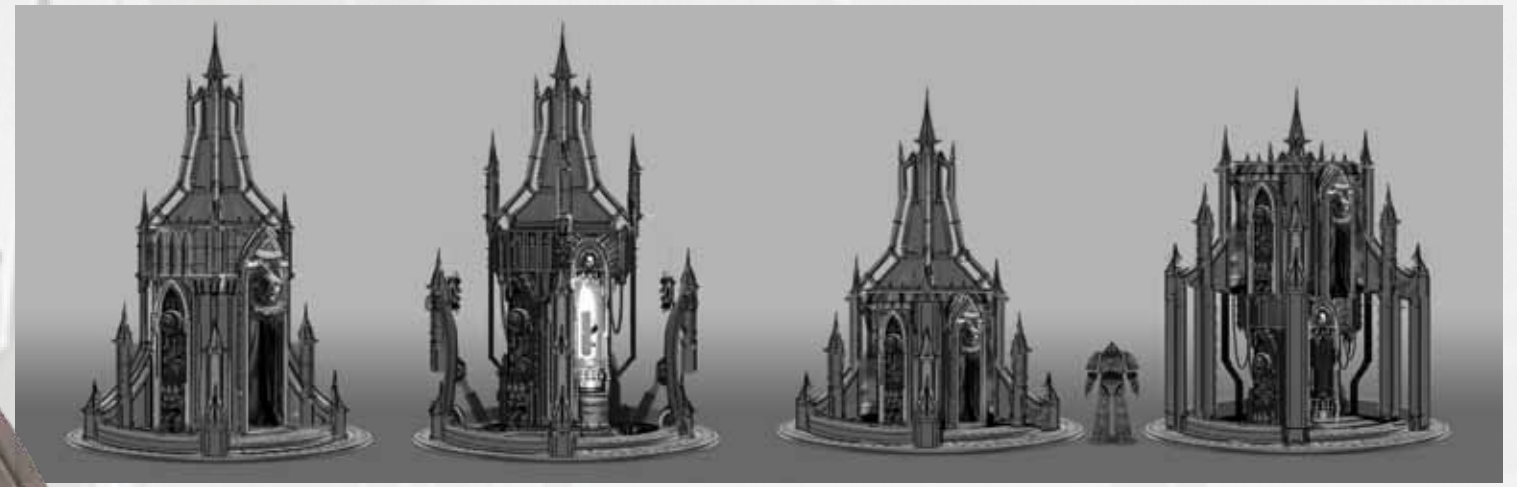

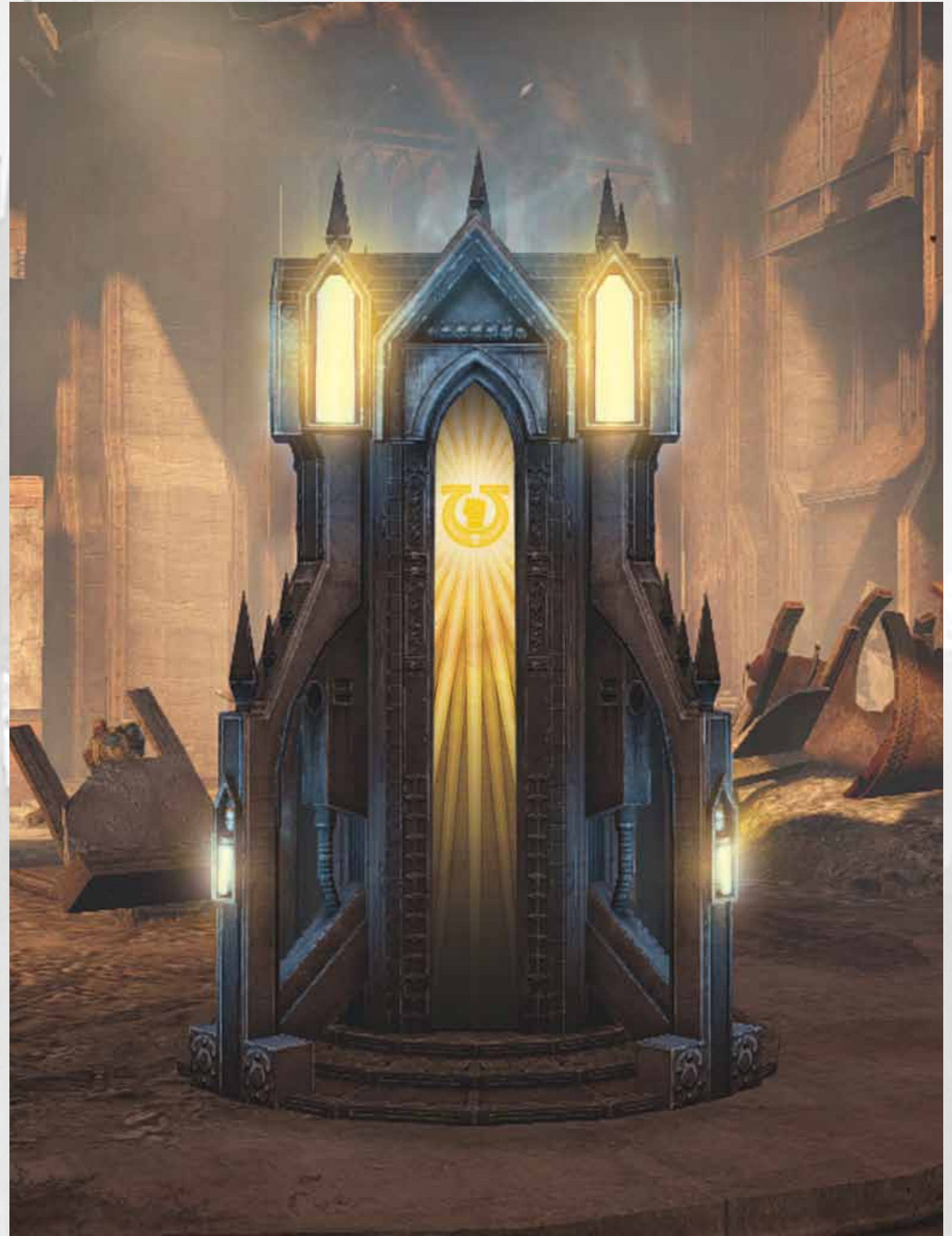
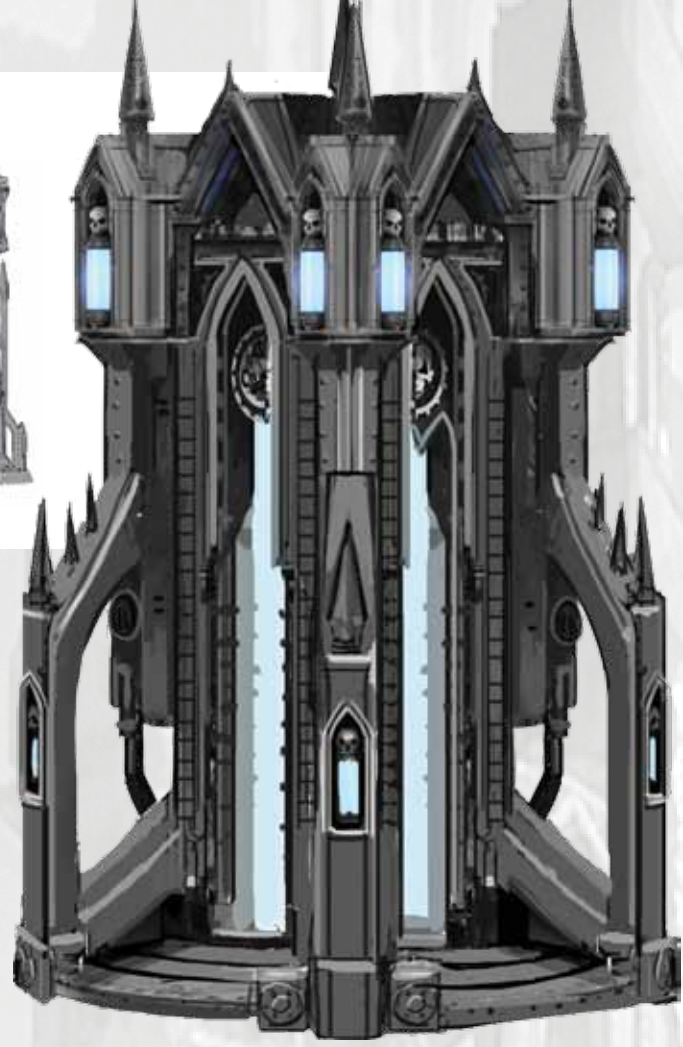
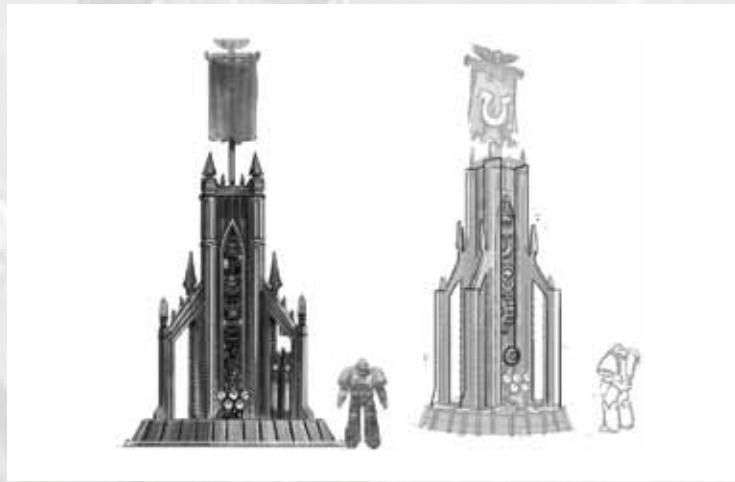
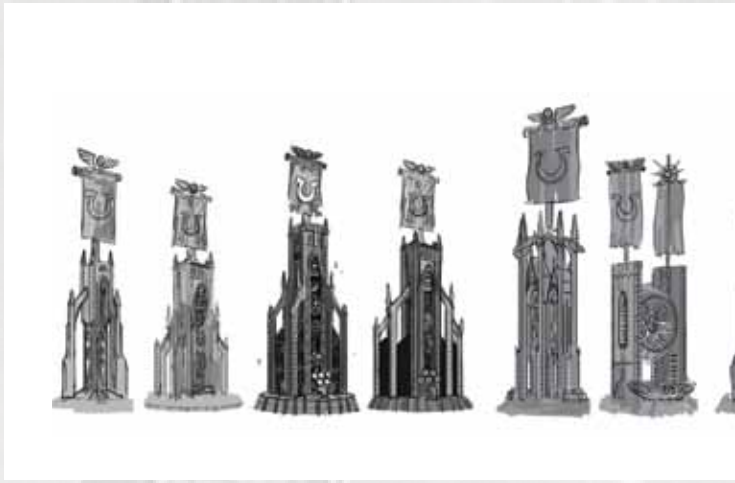







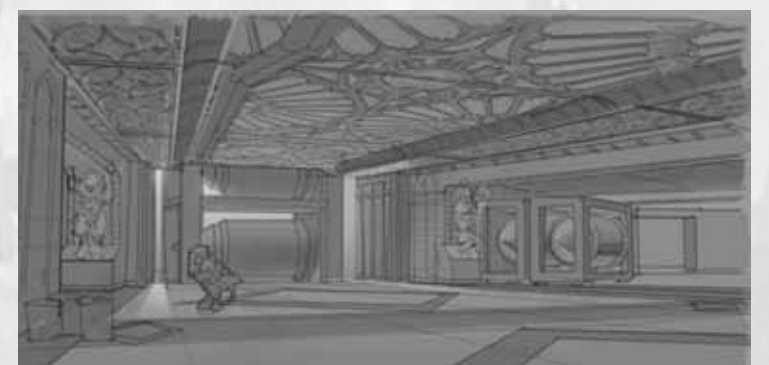
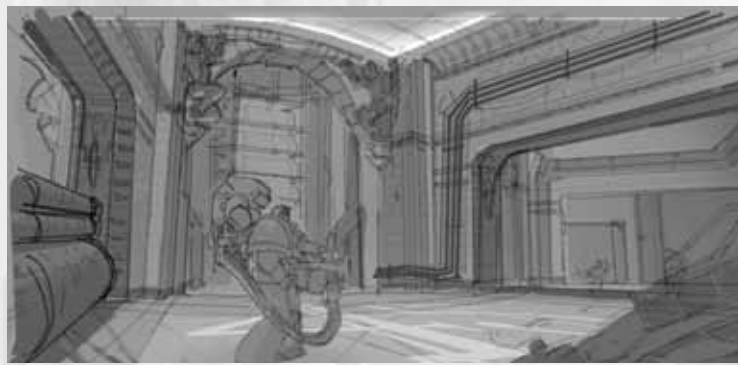
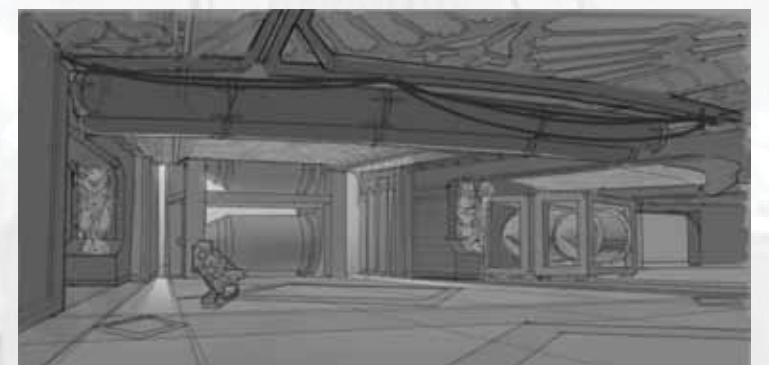
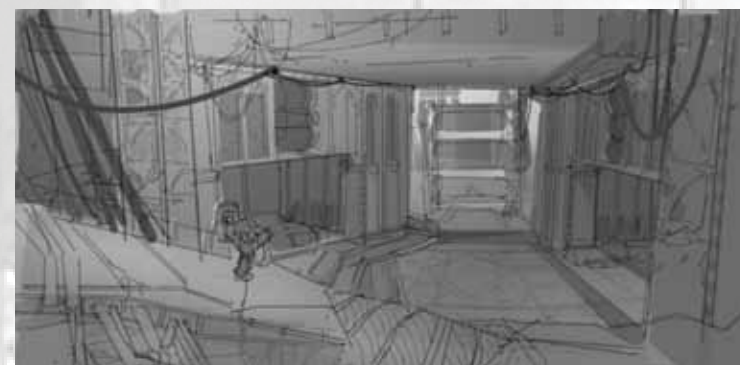
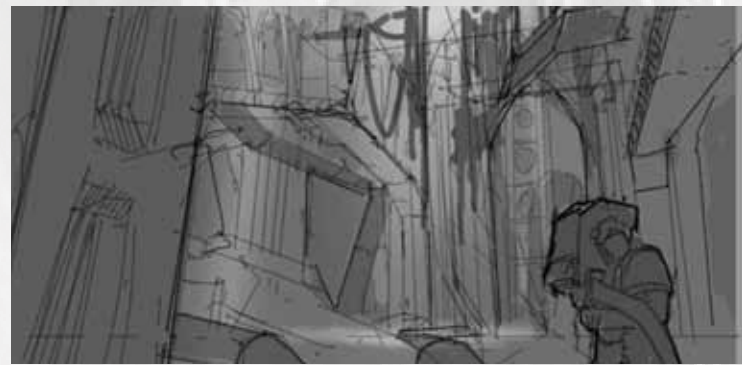
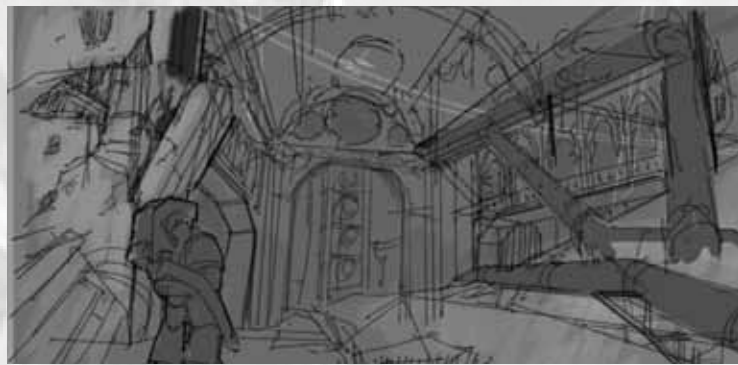
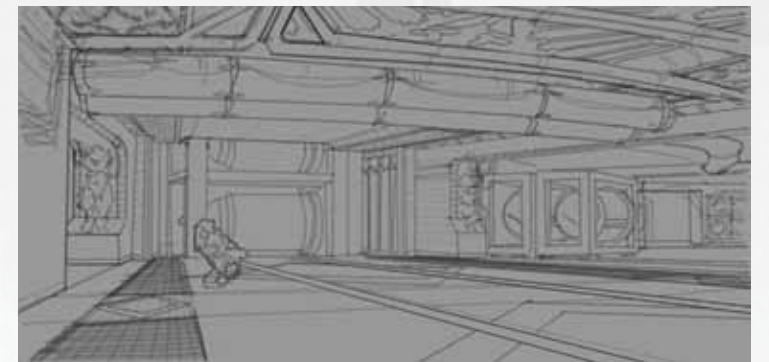
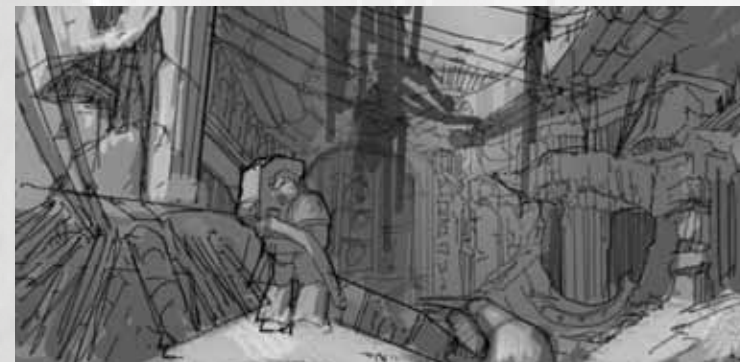
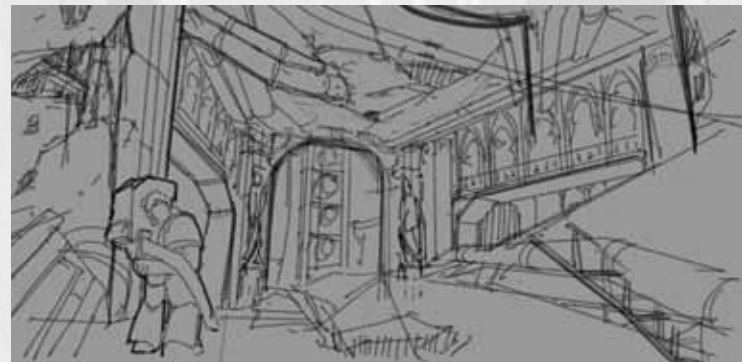
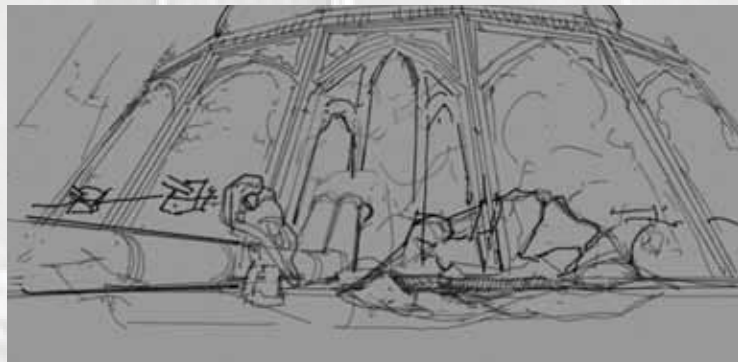
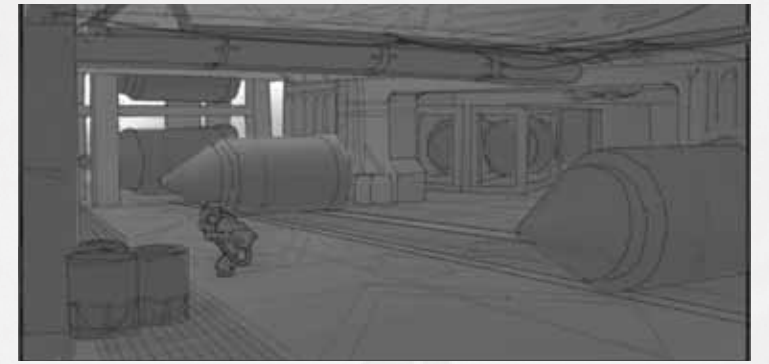
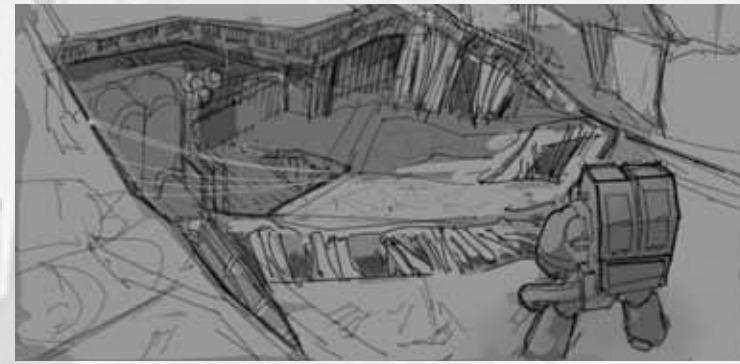
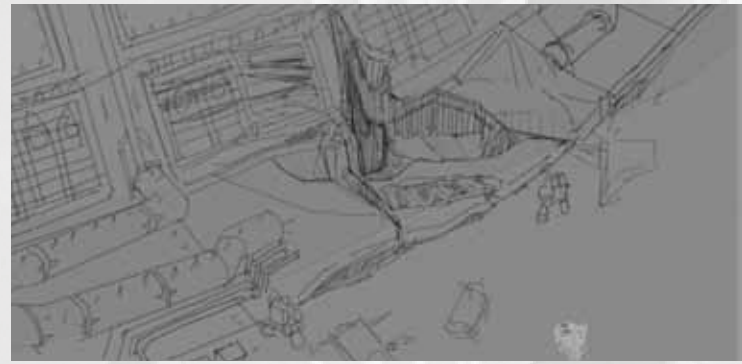
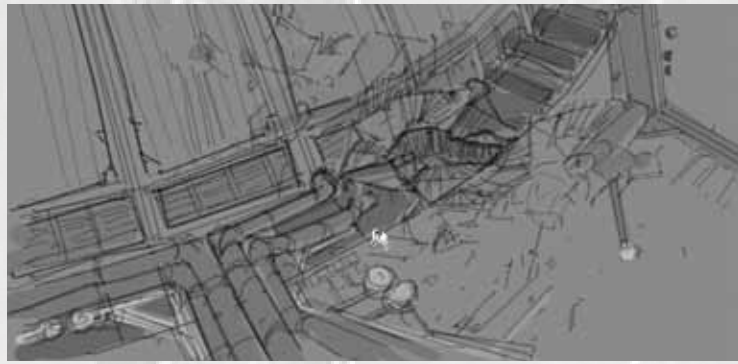

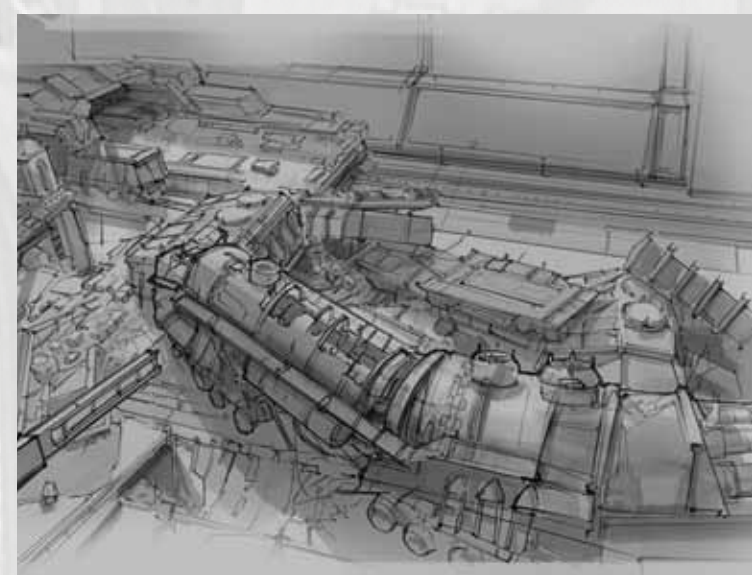
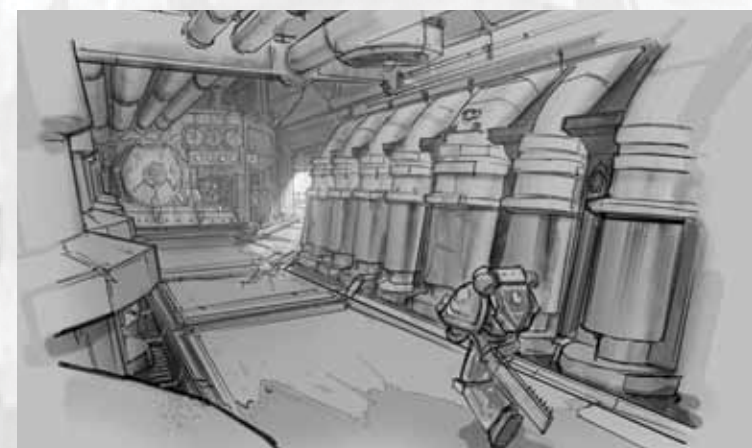
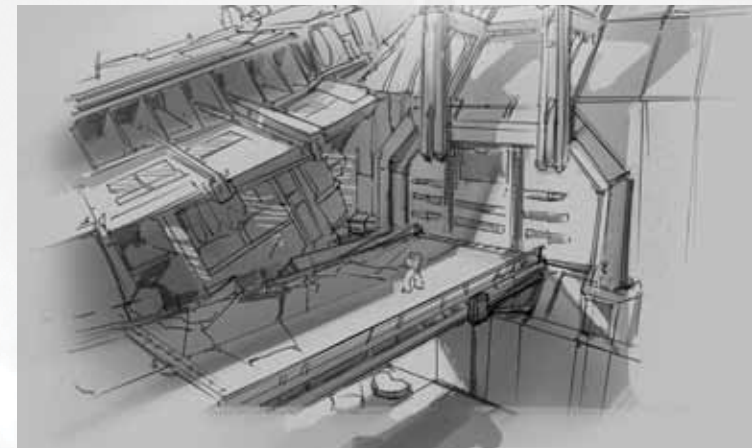
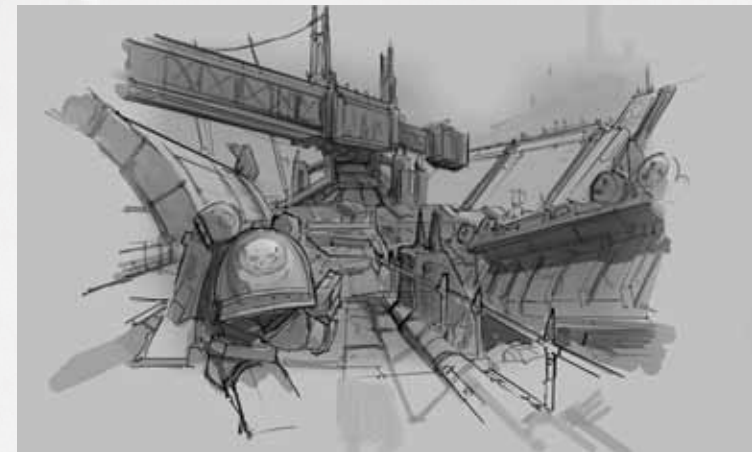
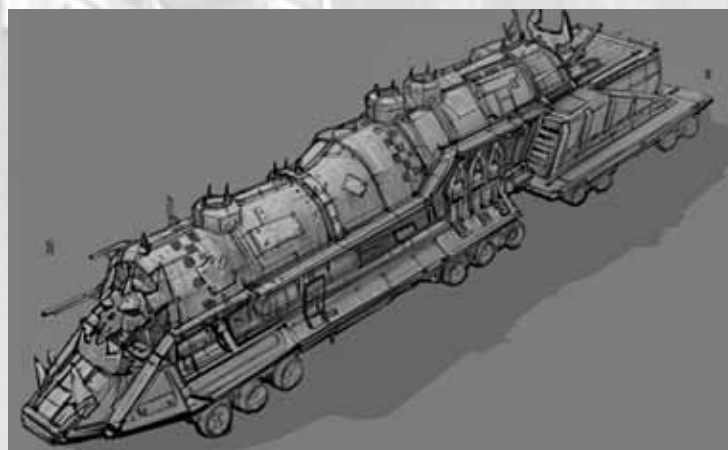
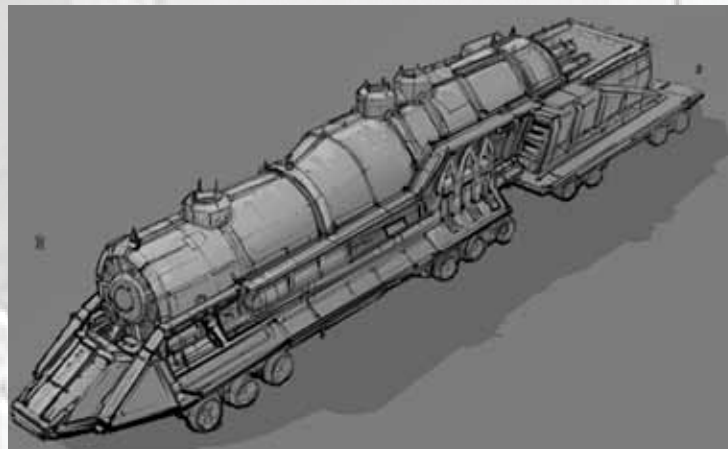
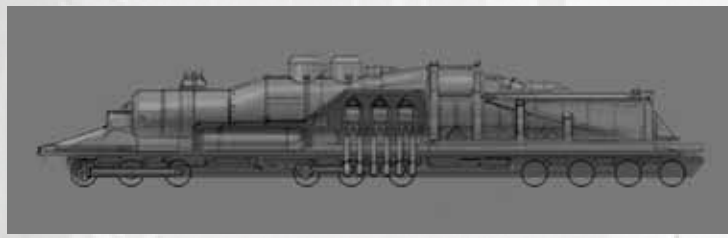
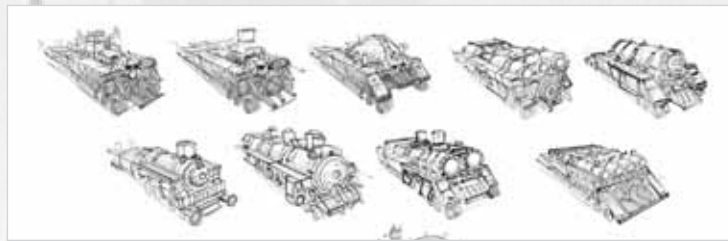
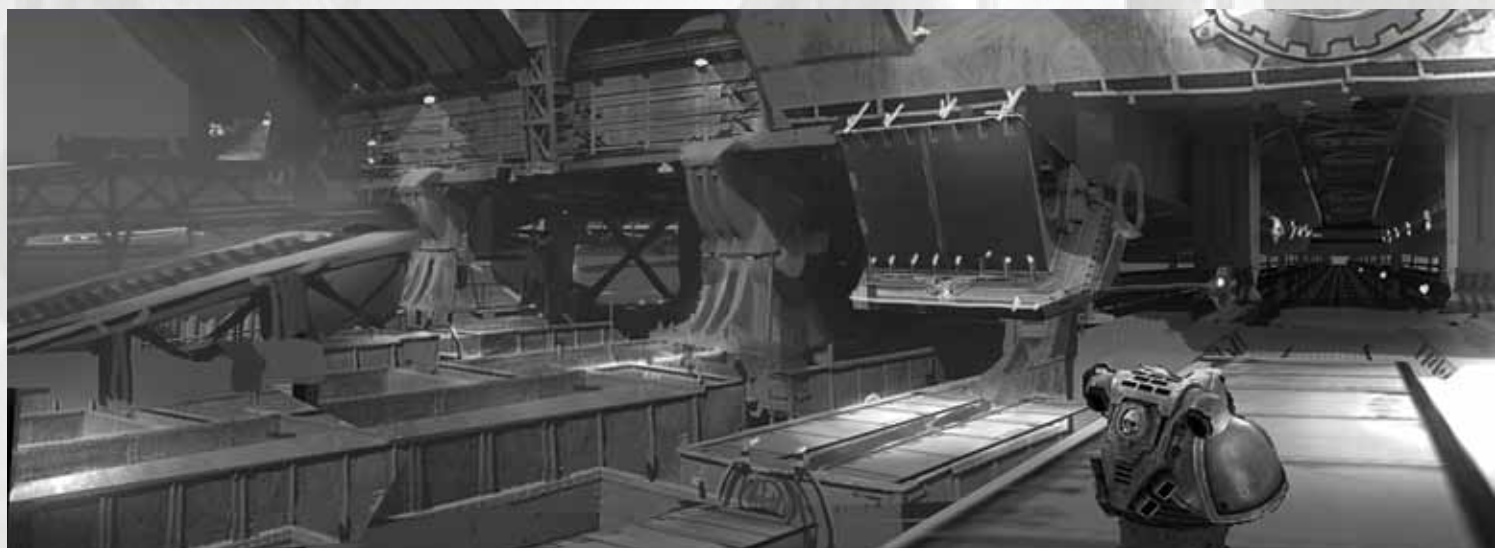

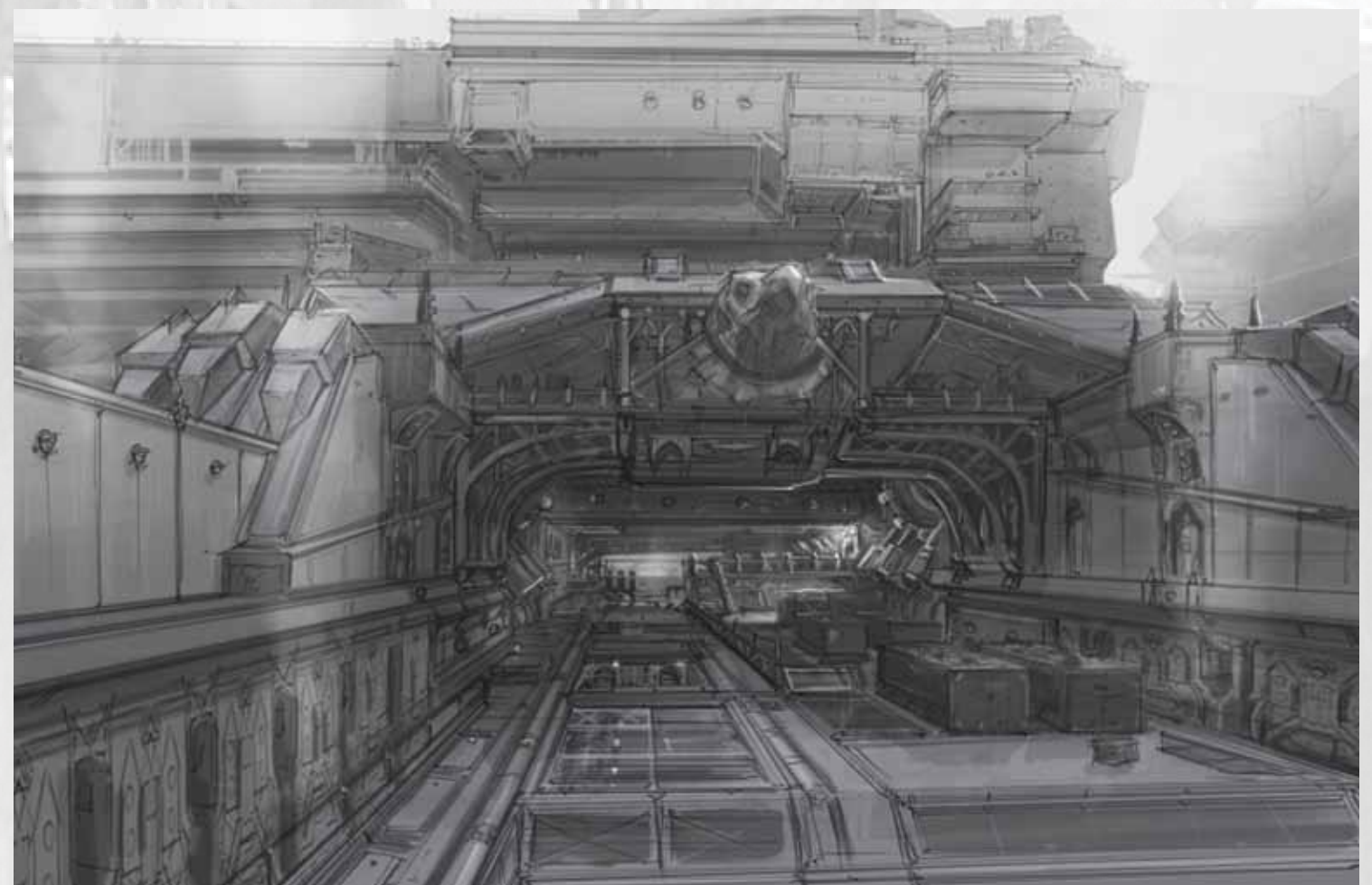
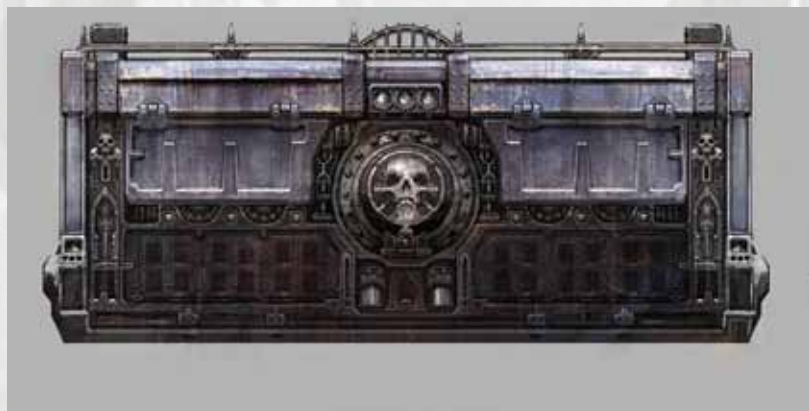
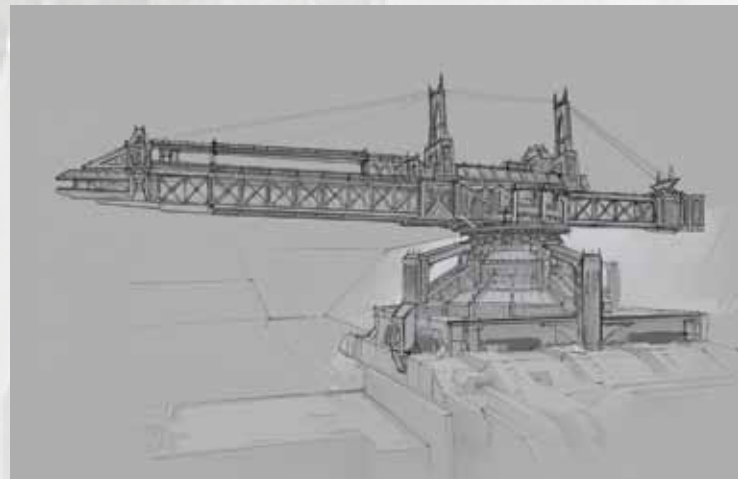
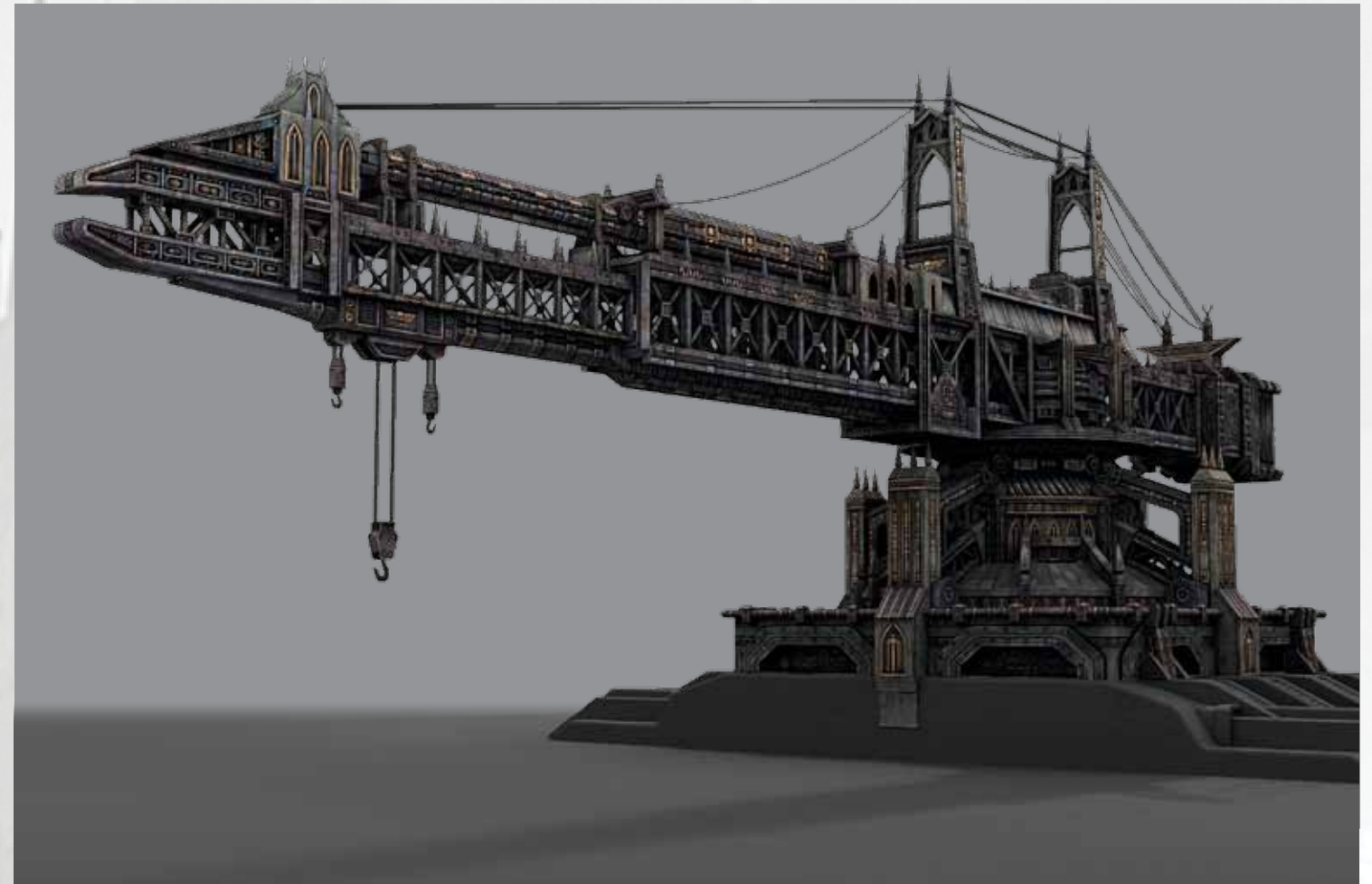
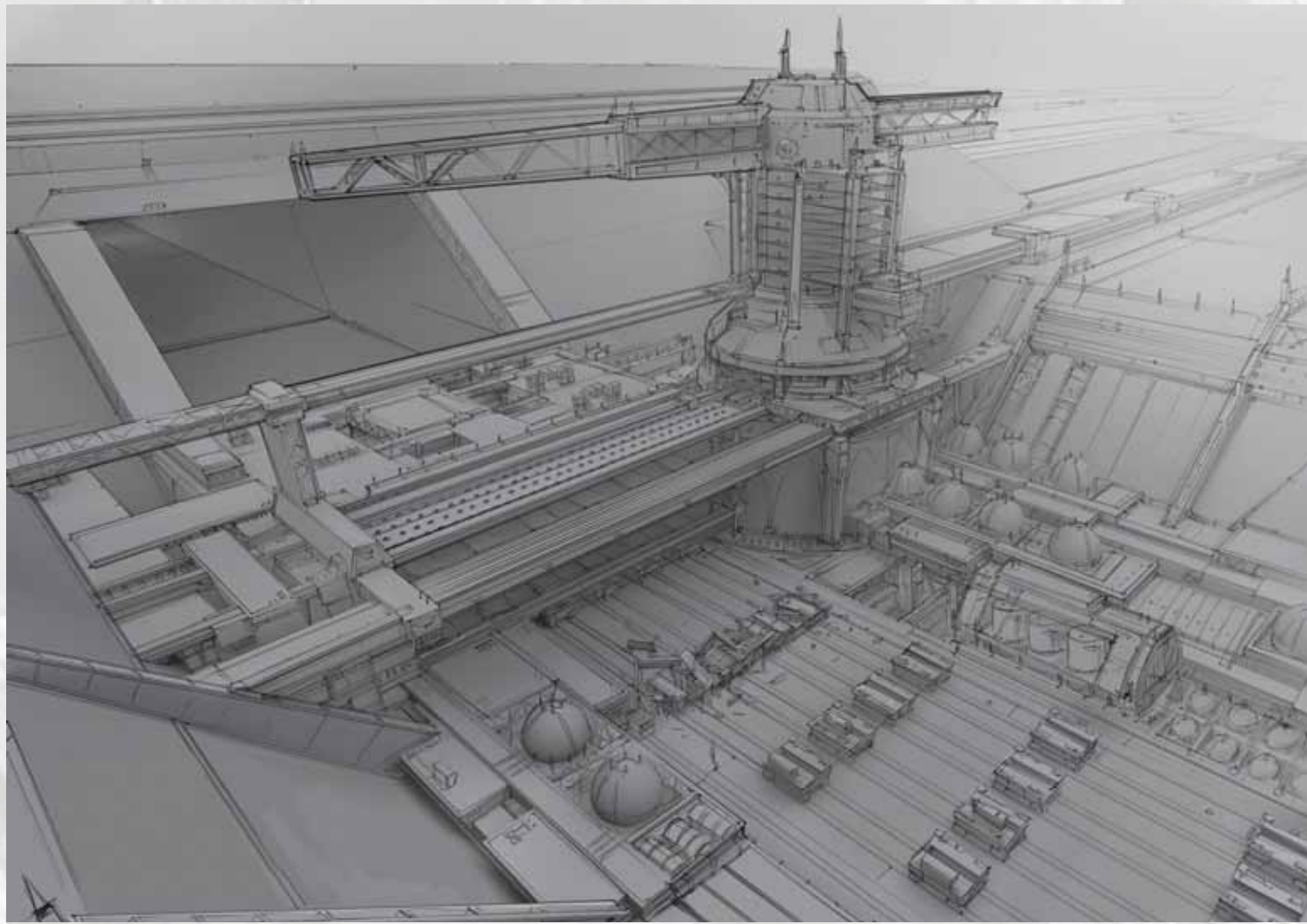

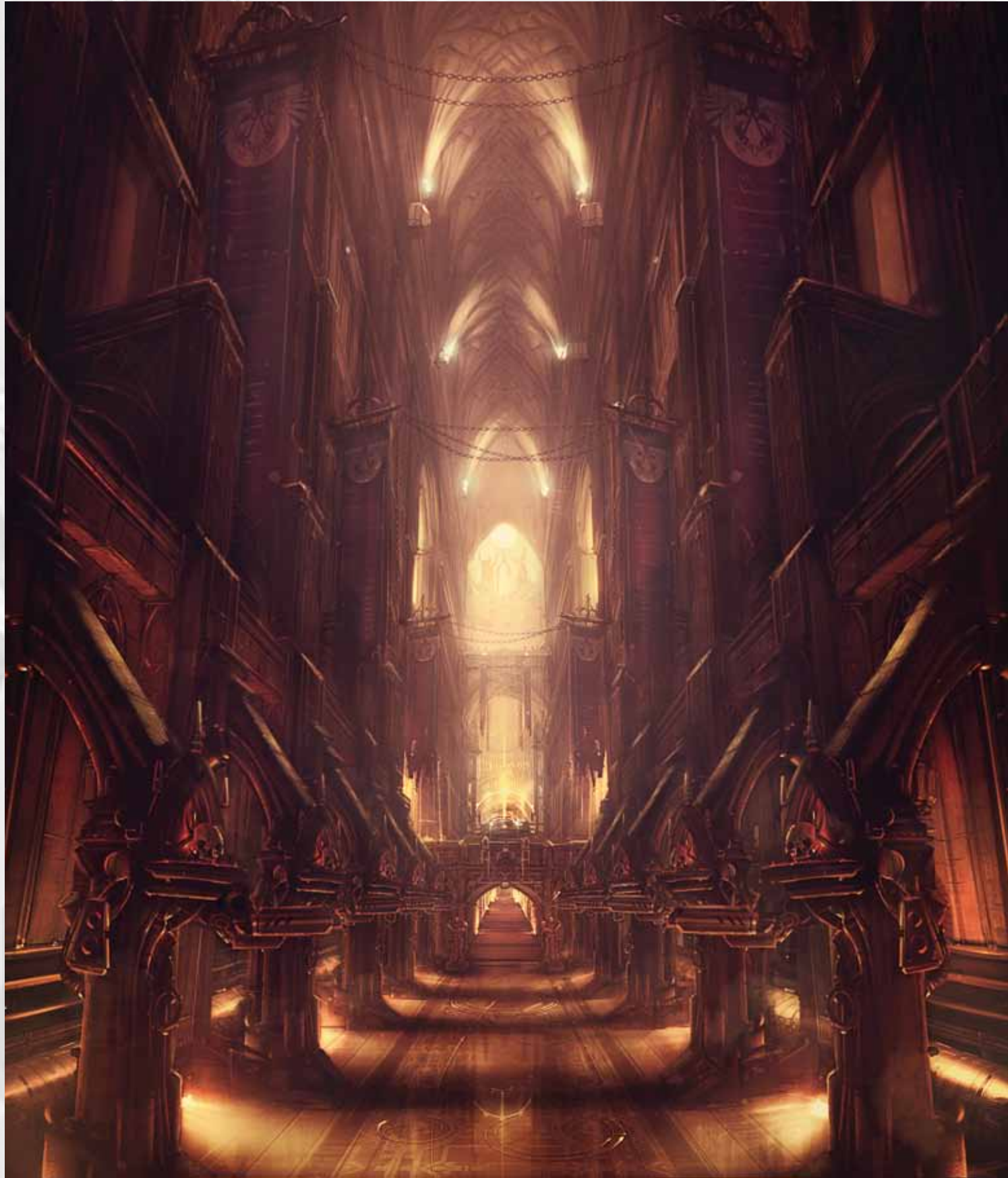

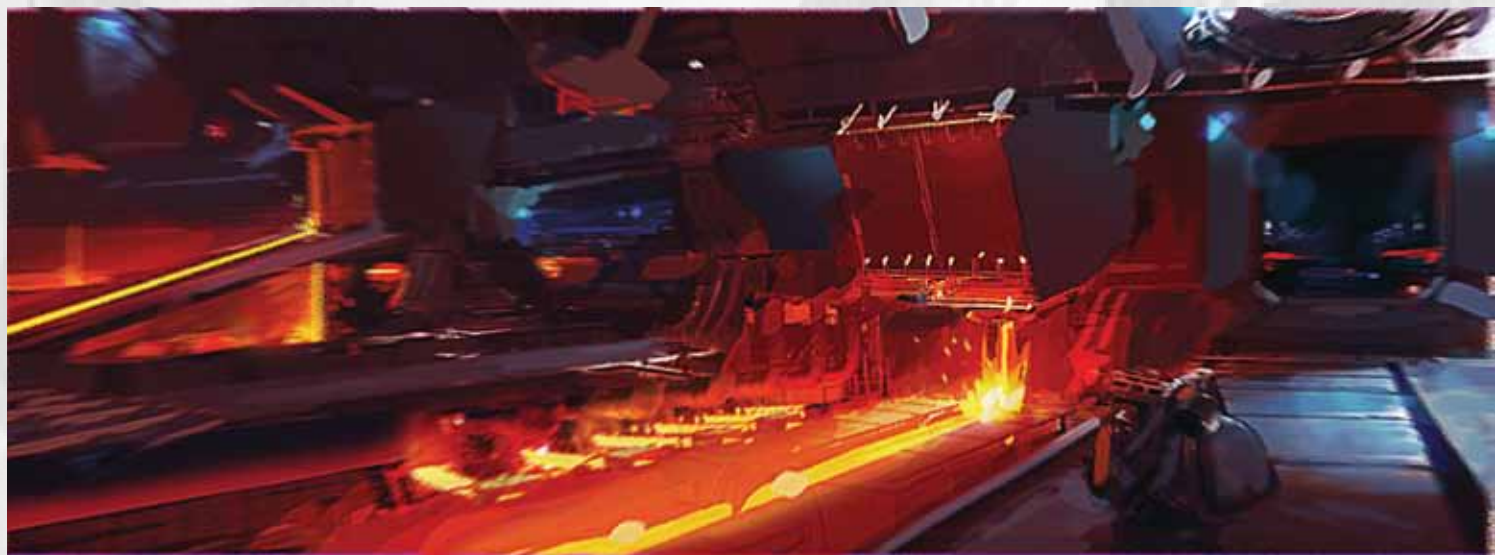



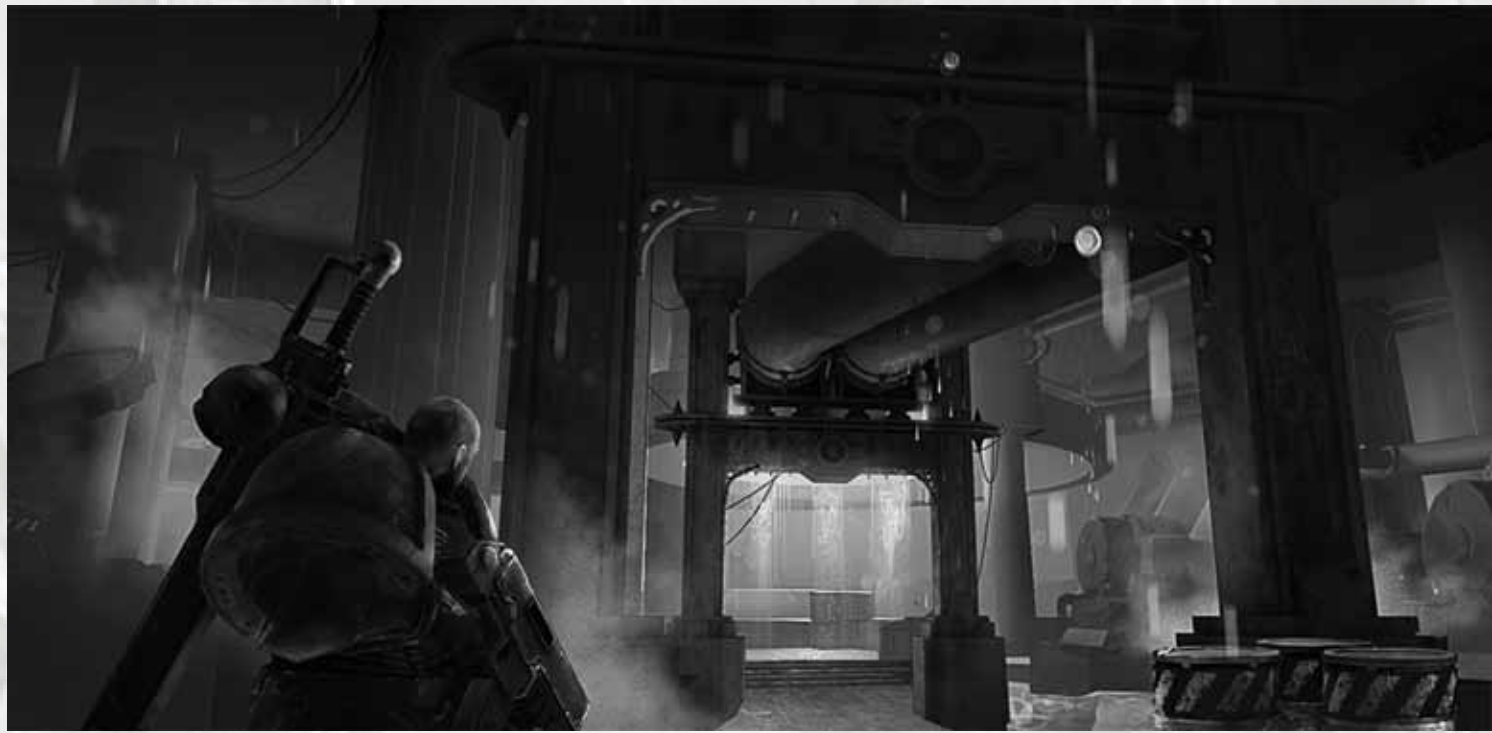
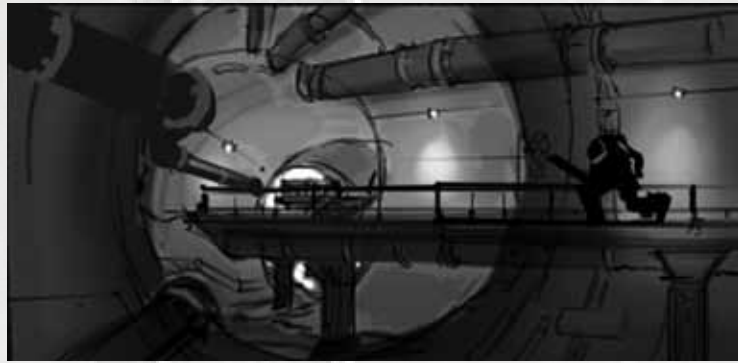

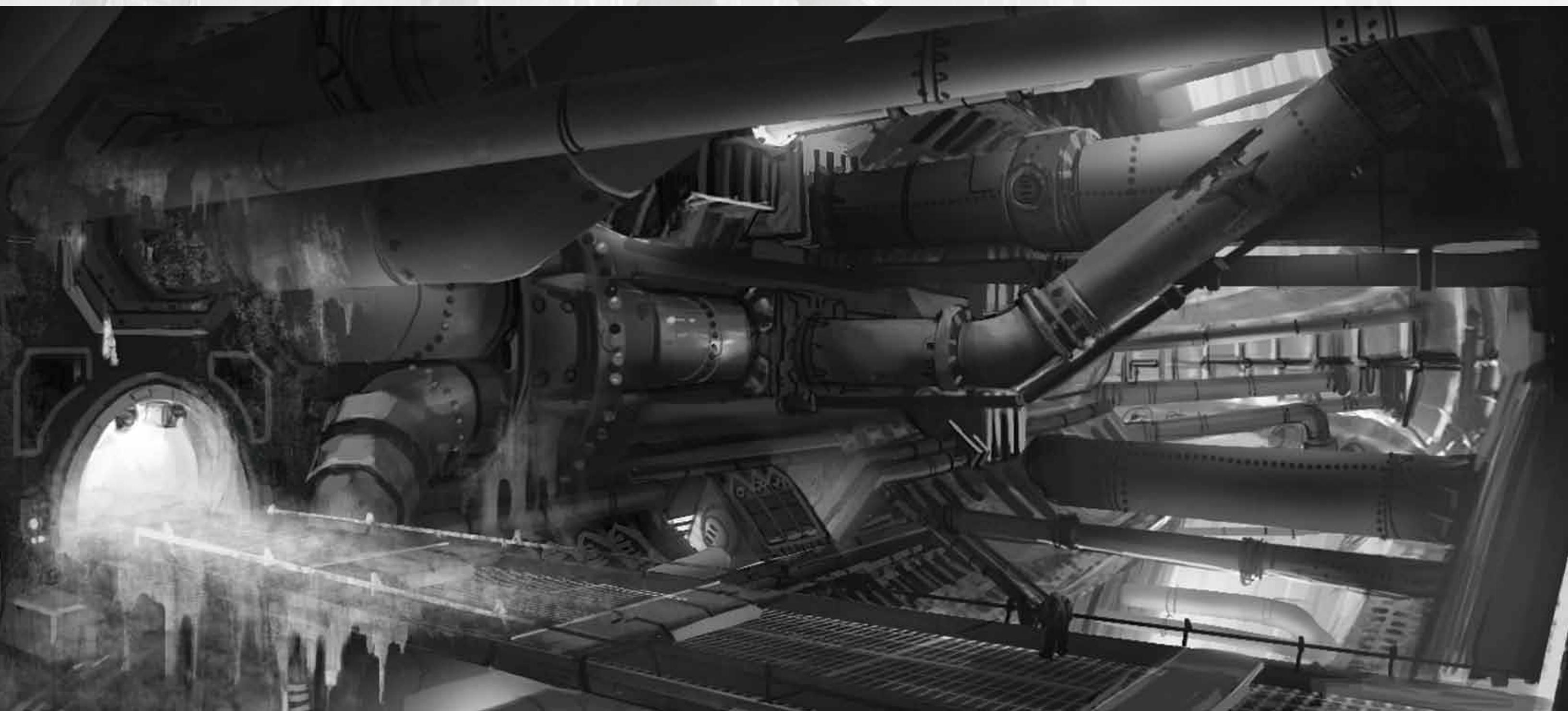
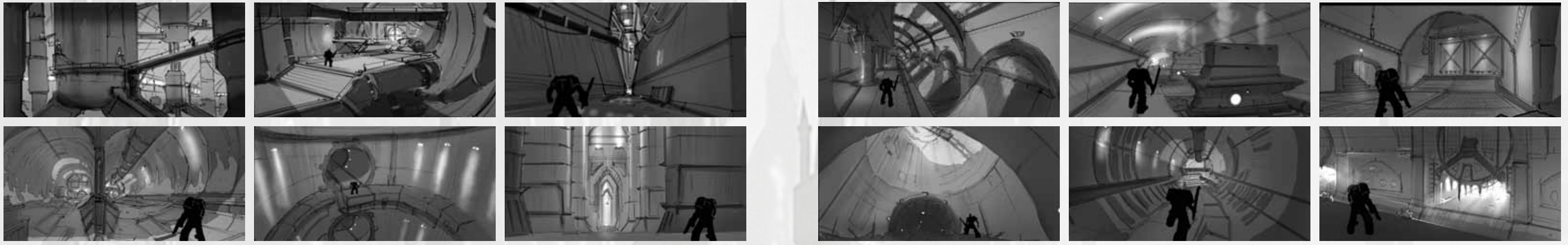

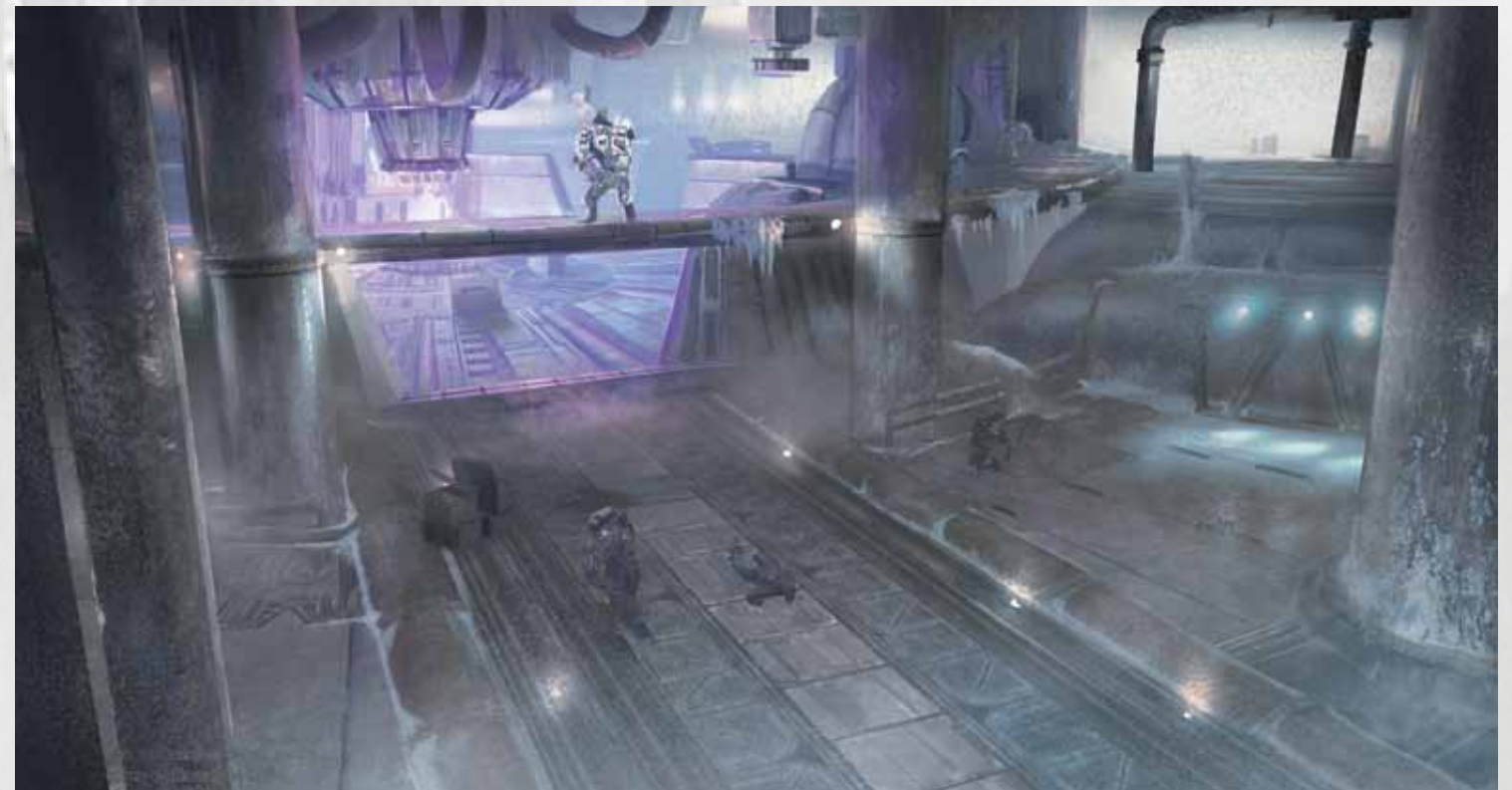
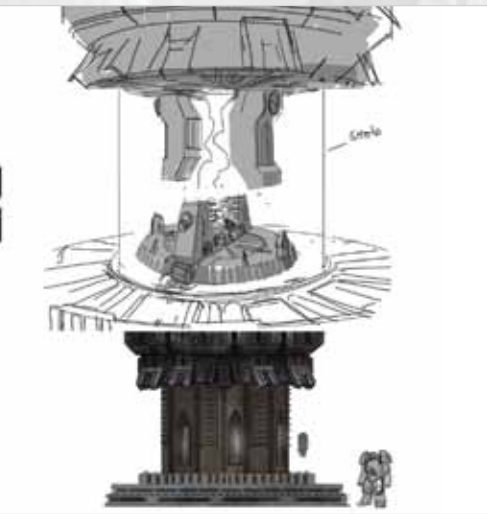
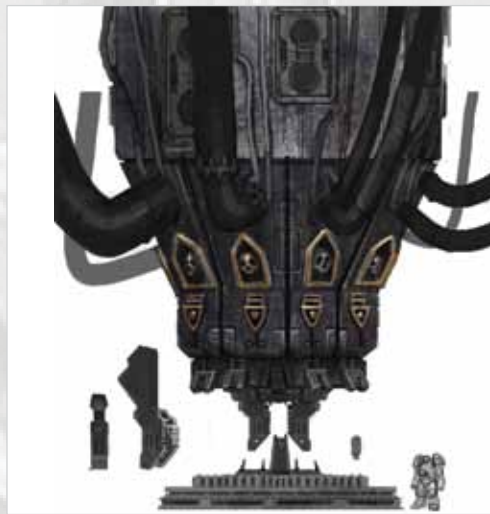
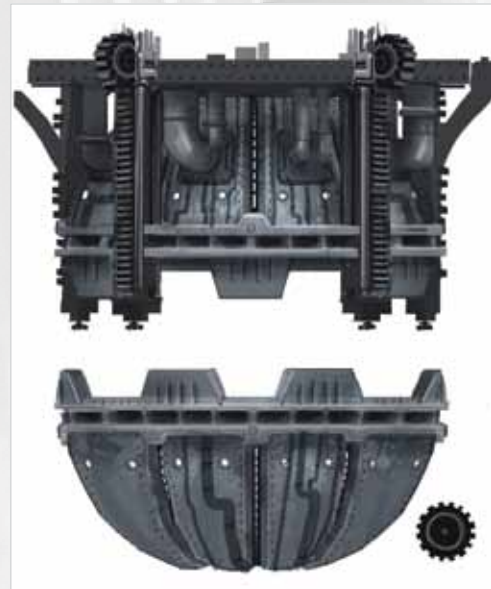
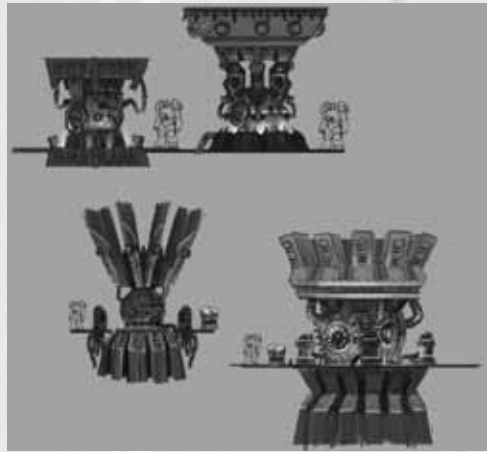
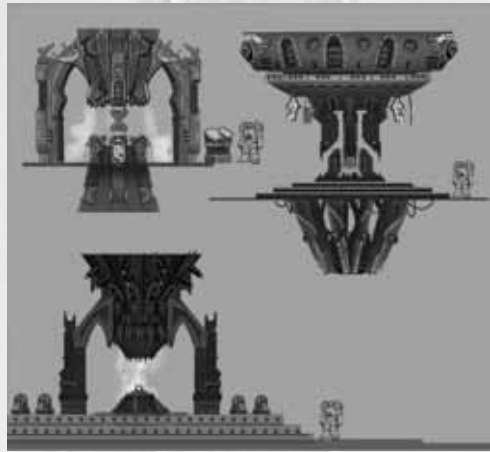



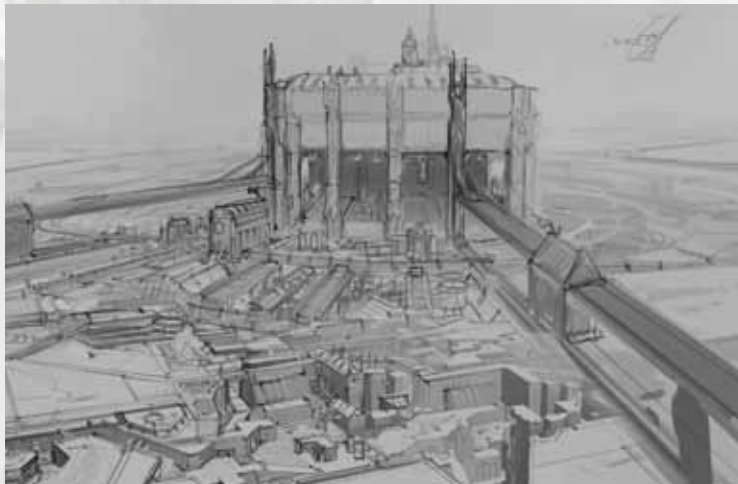
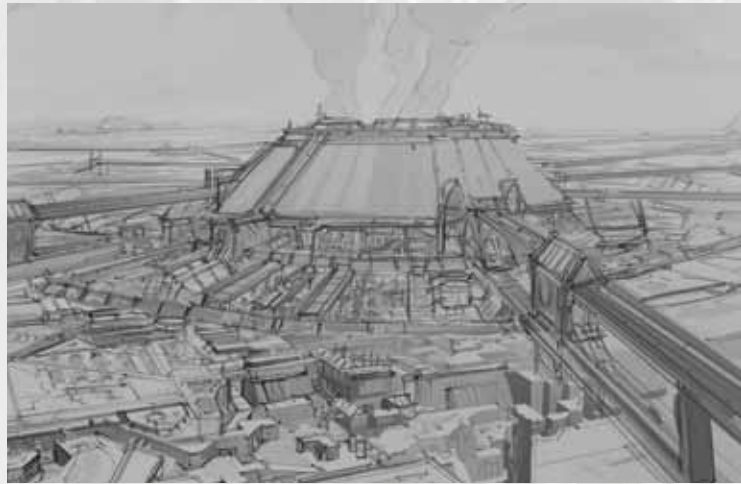

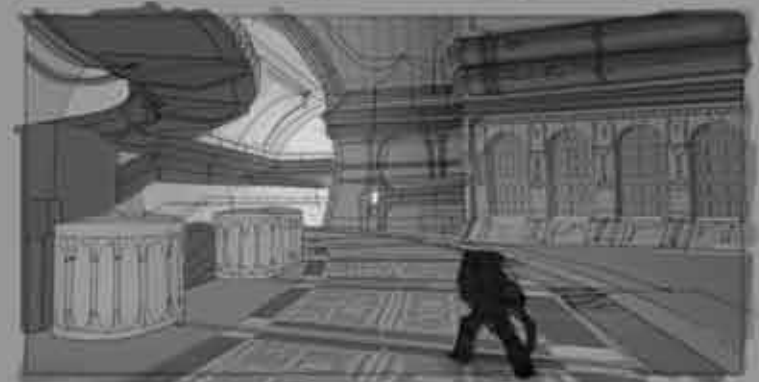
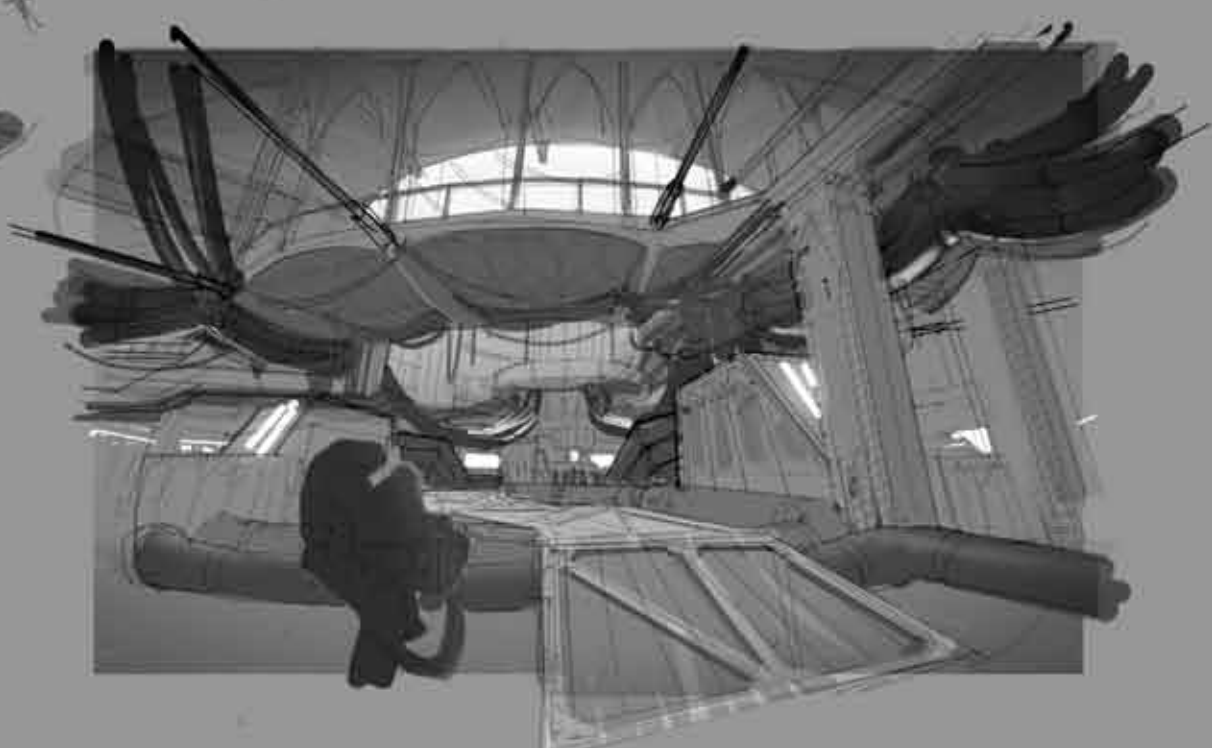
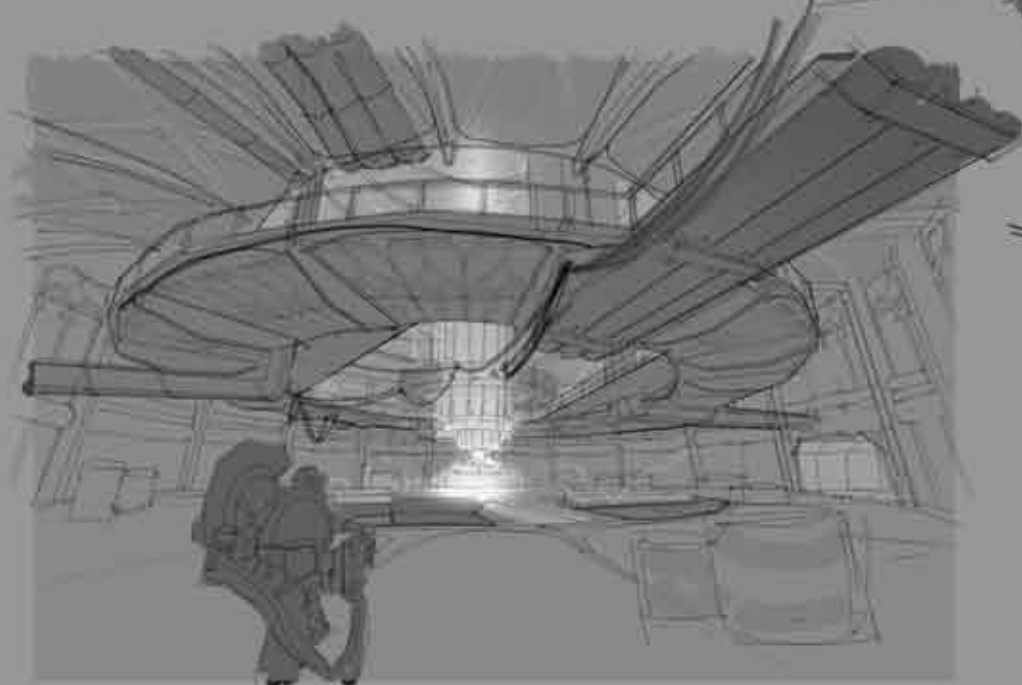
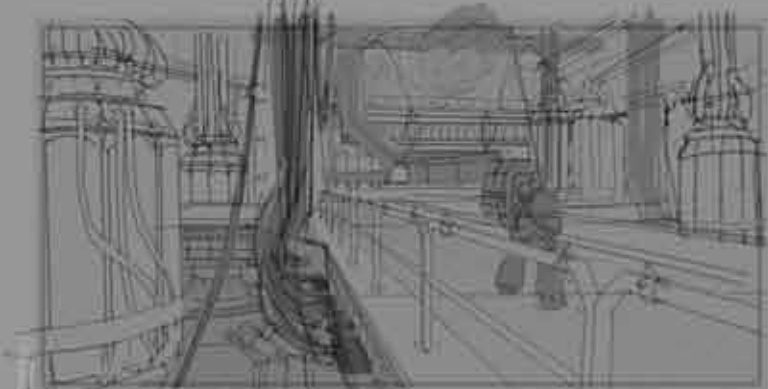
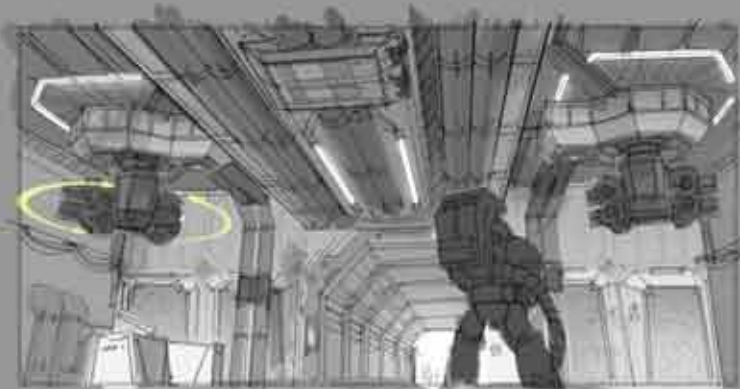
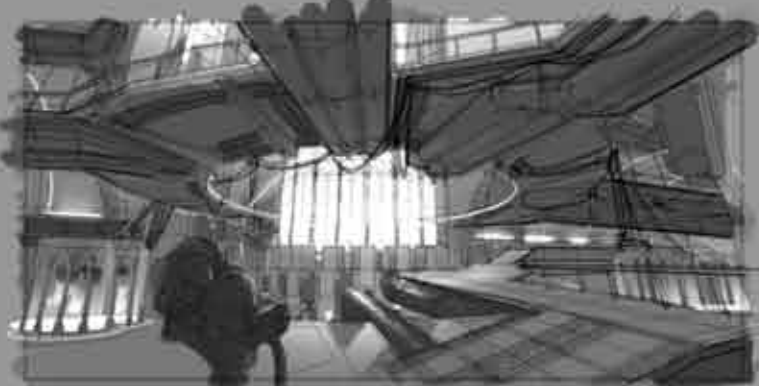
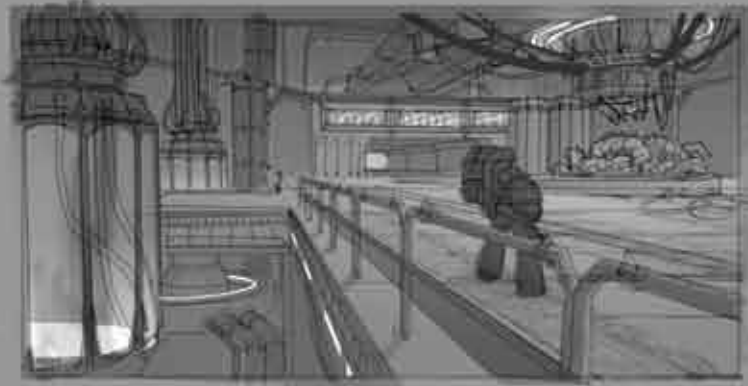
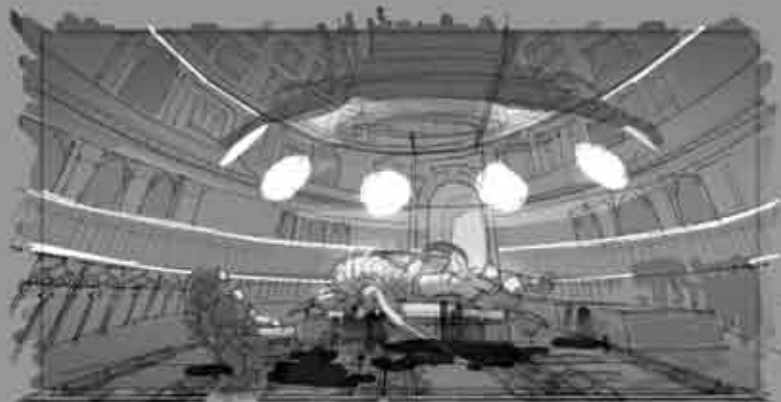



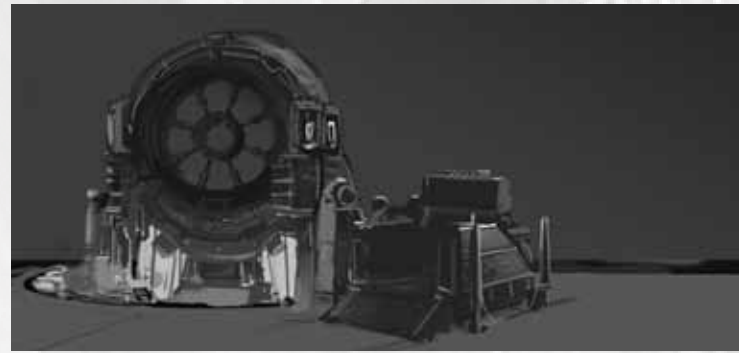
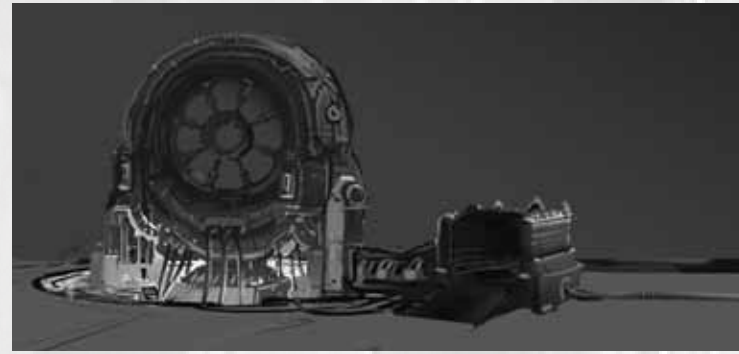
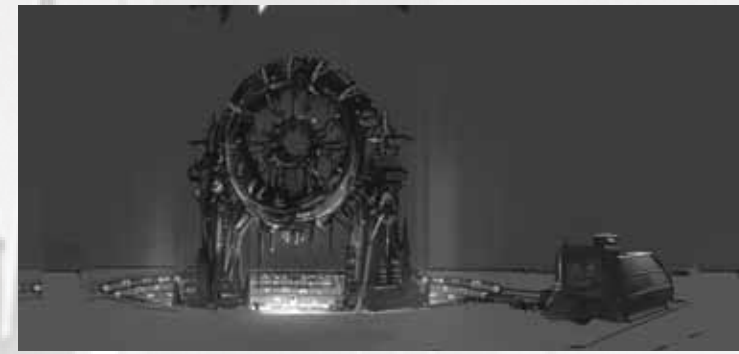
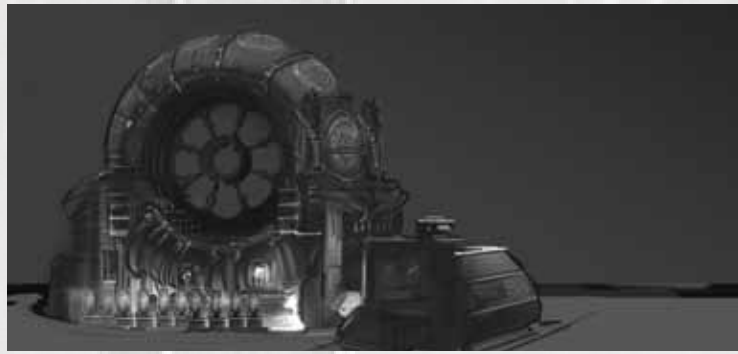





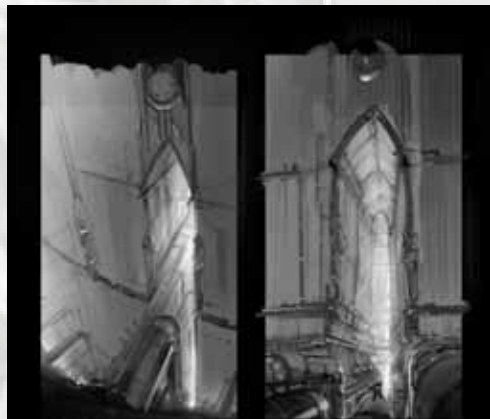
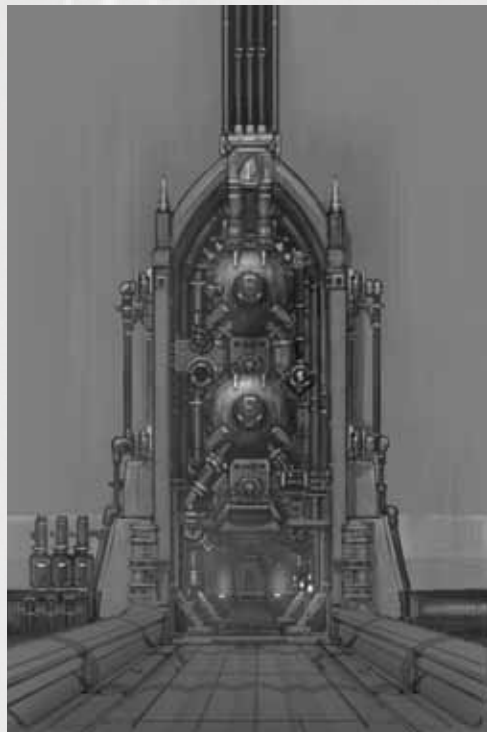
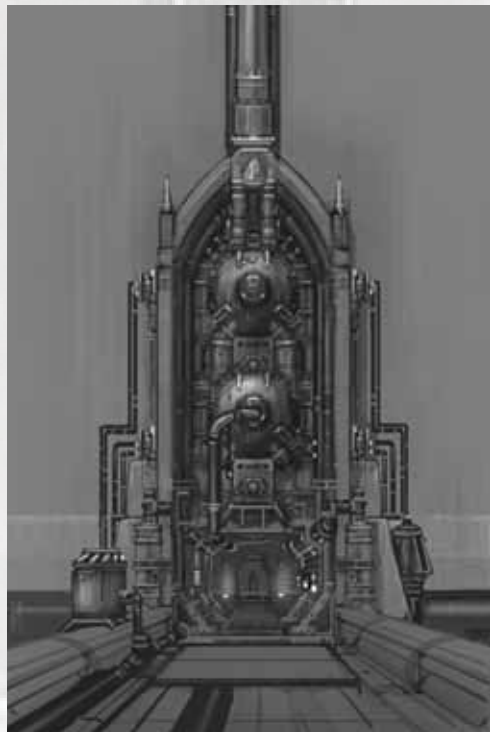

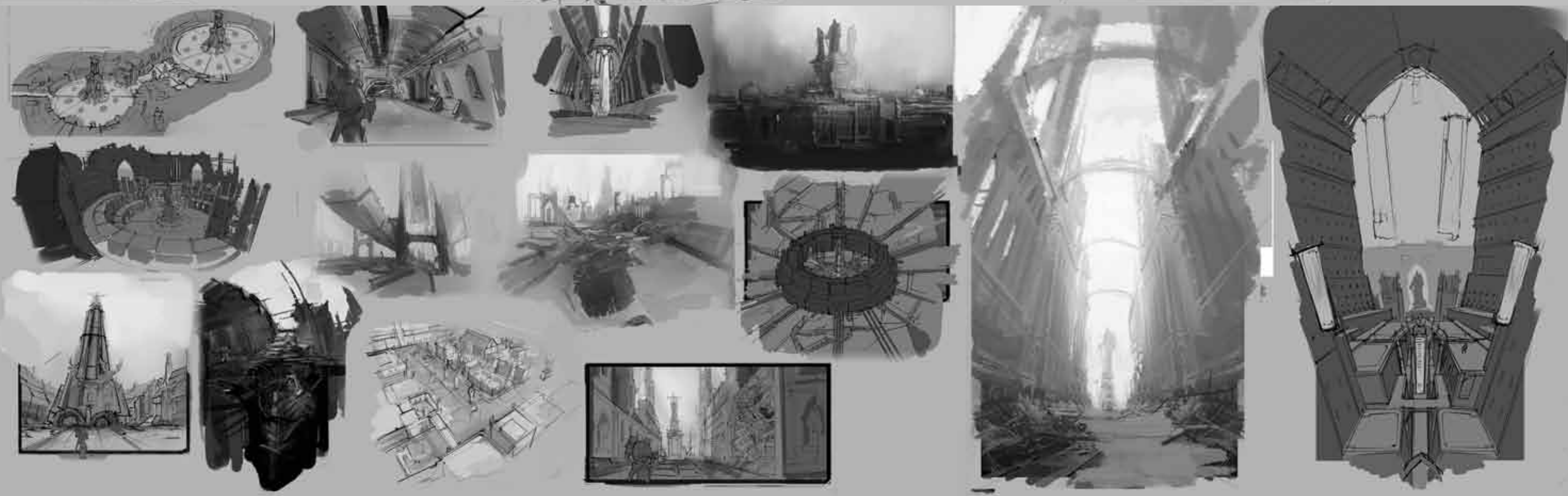
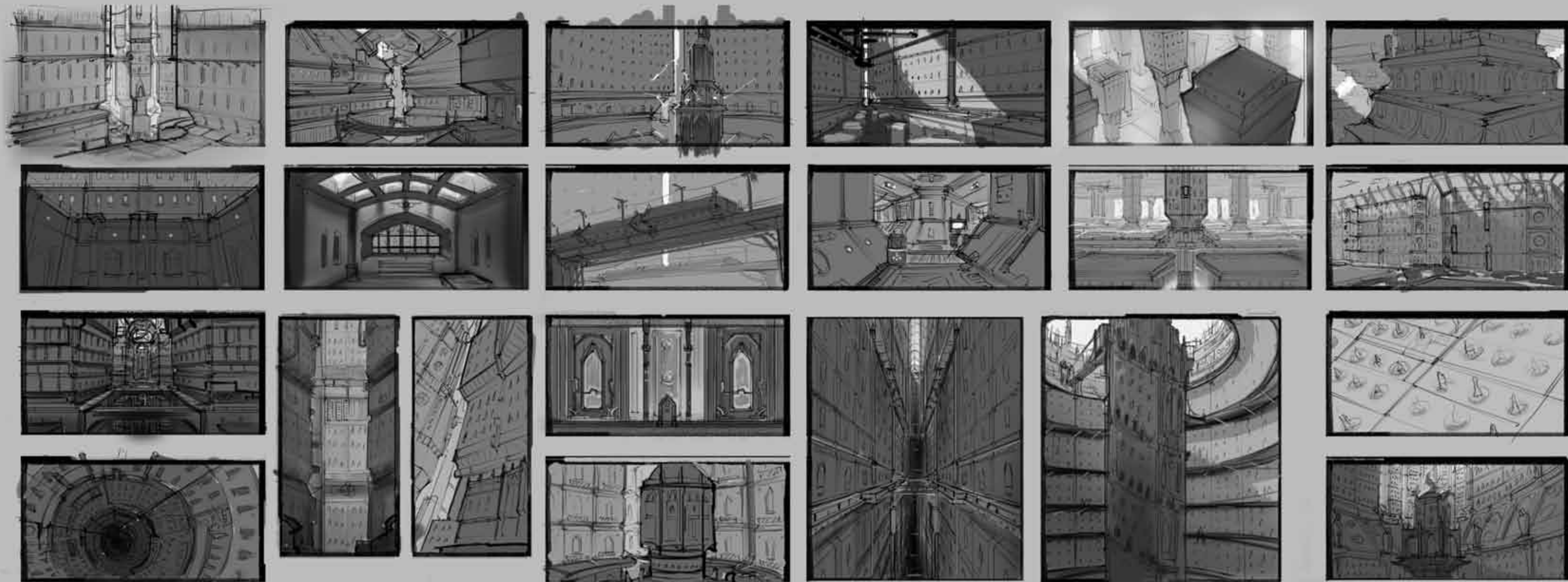





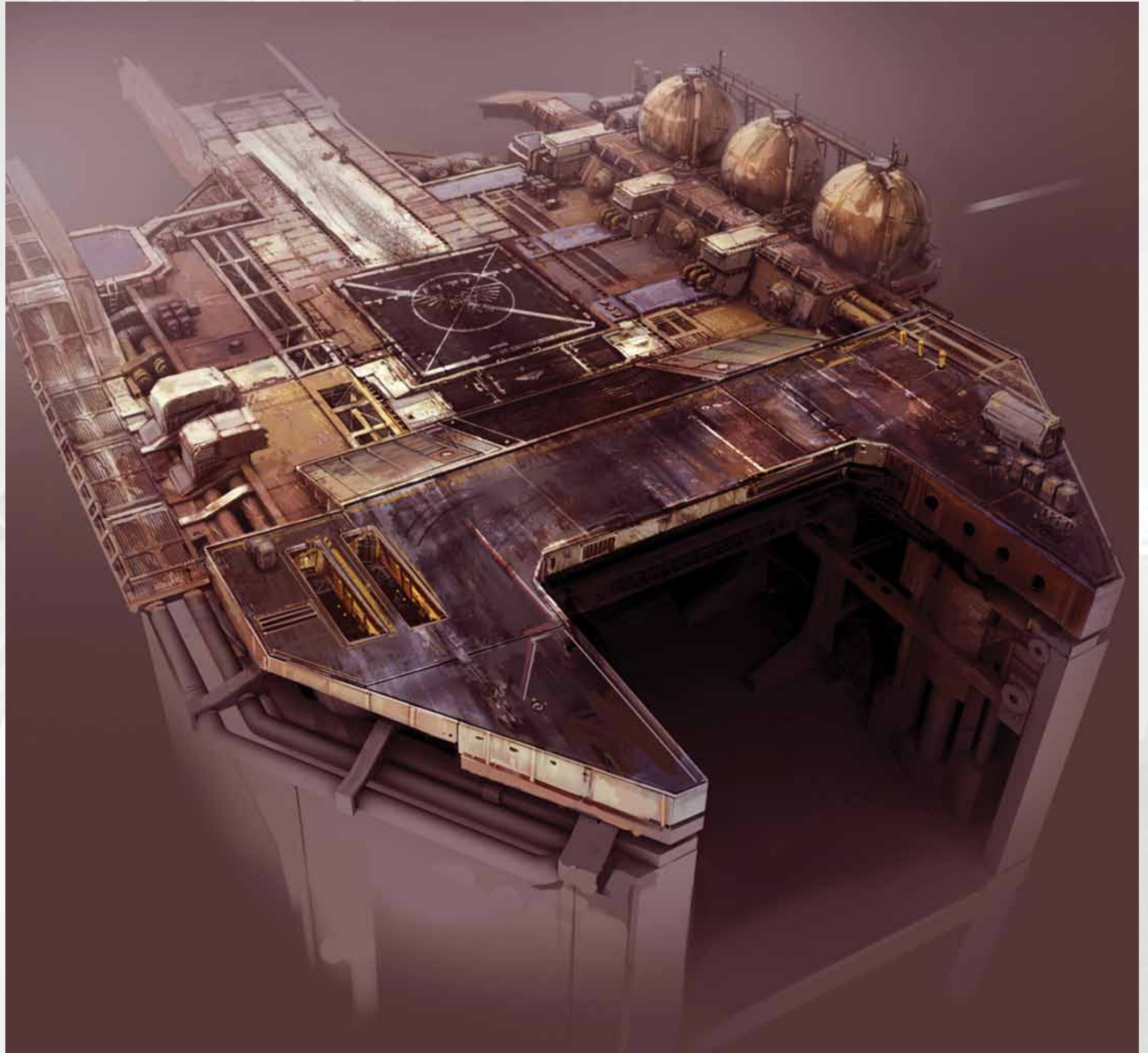
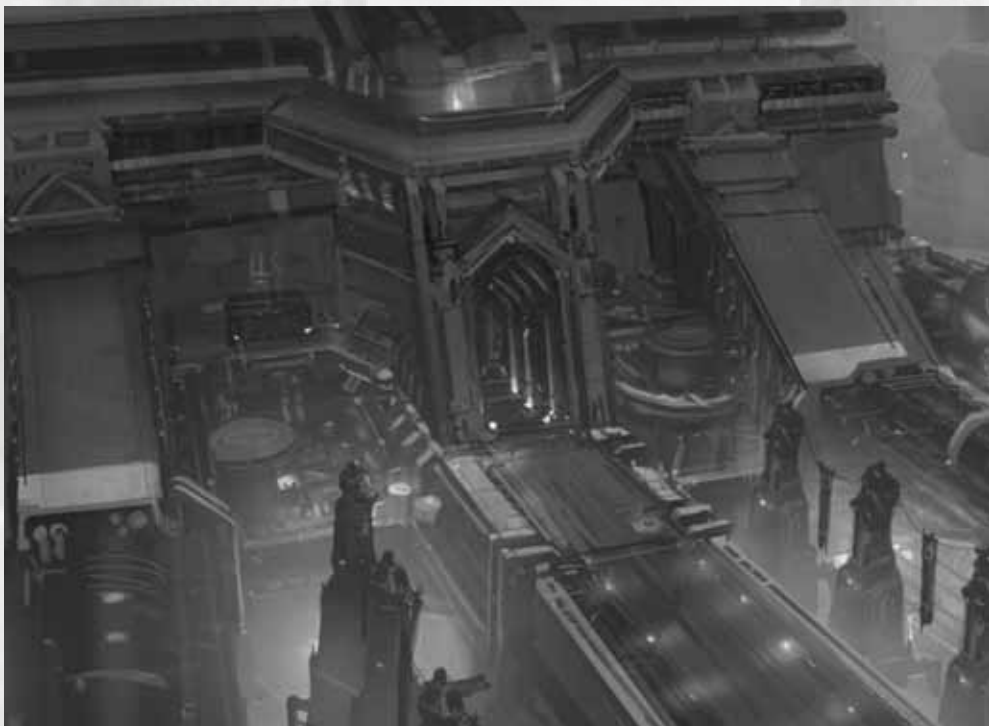

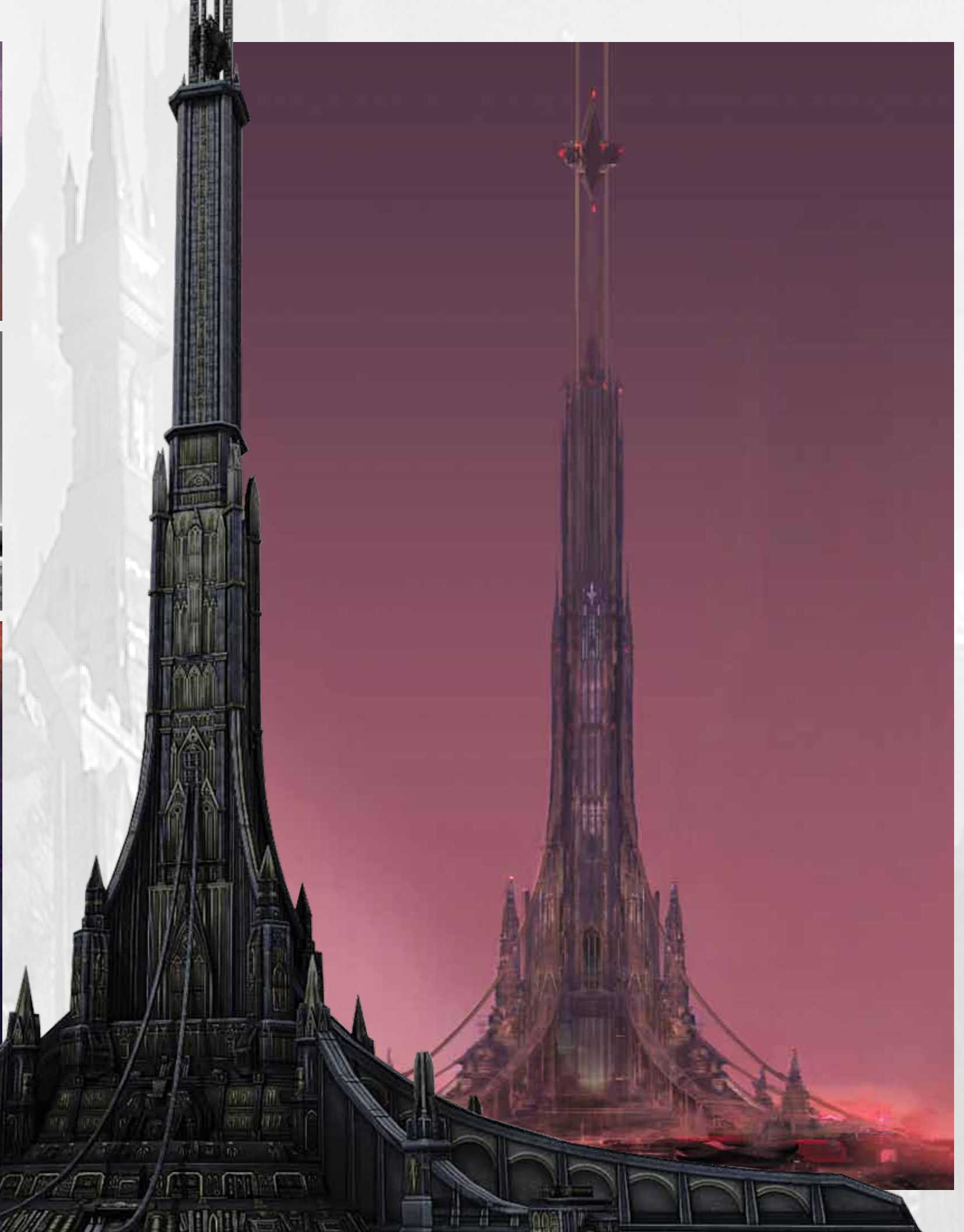

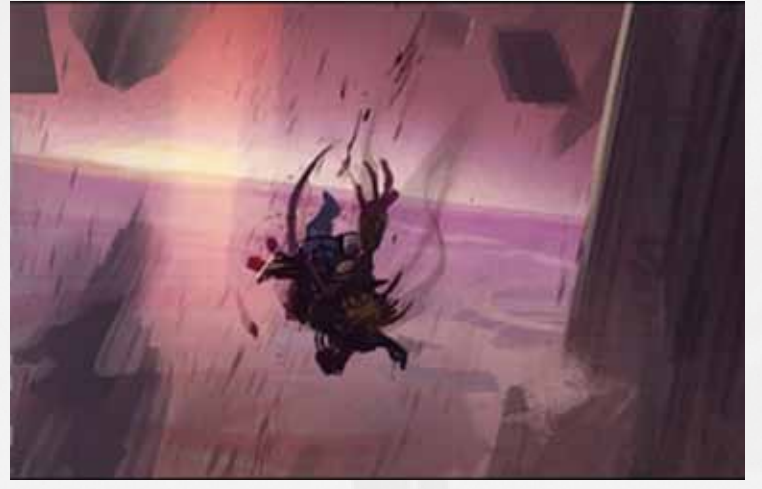
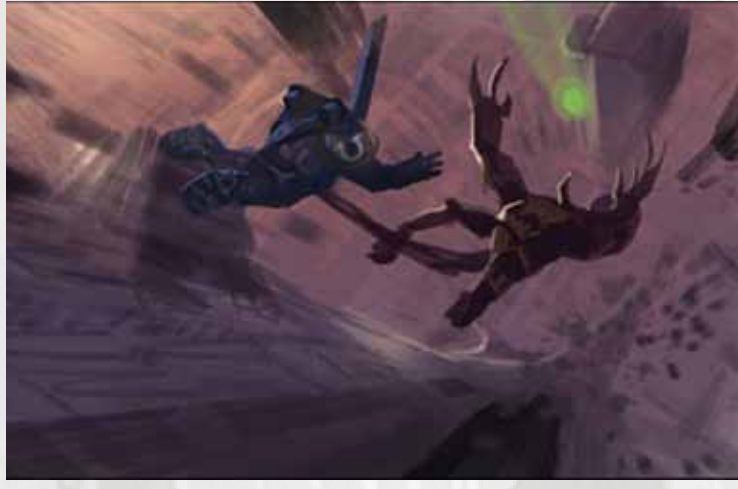
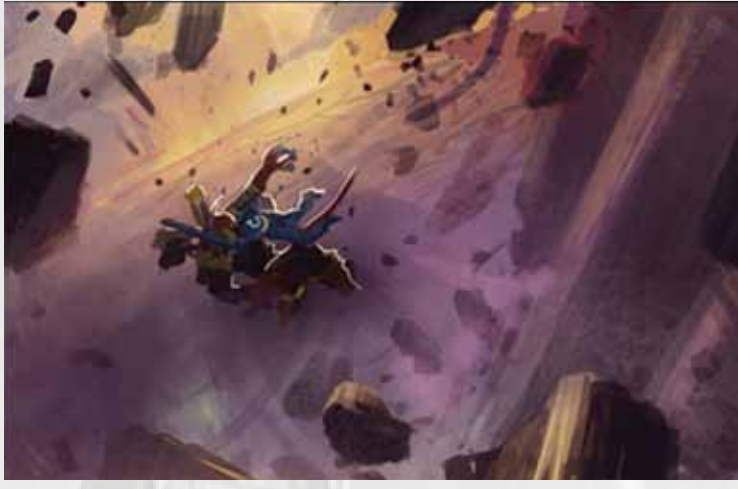



THE ENEMIES OF HUMANITY: ORKS







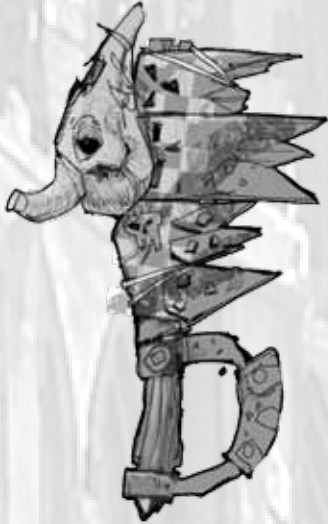
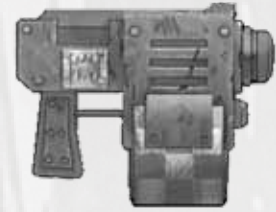





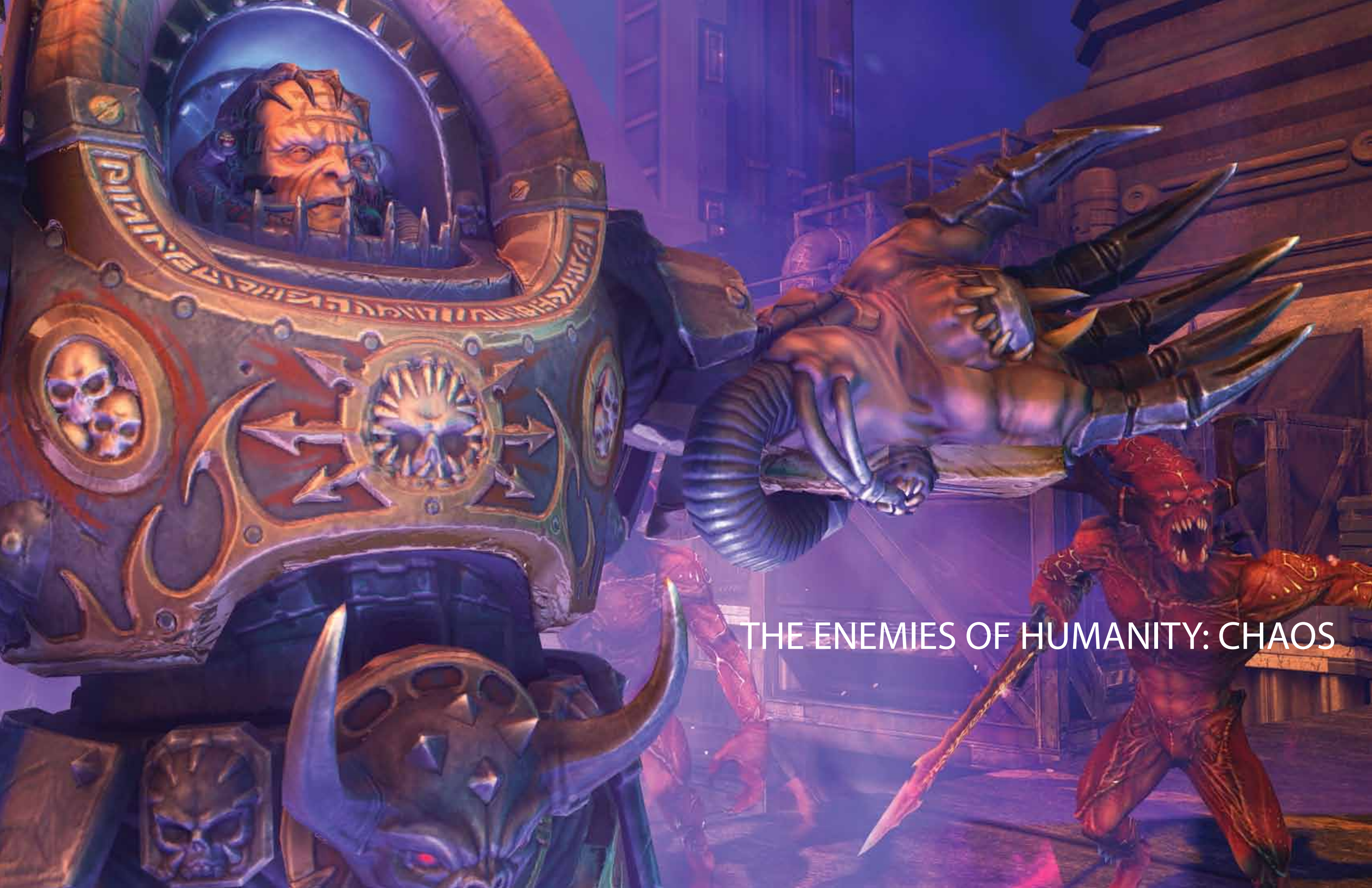

THE ENEMIES OF HUMANITY: CHAOS



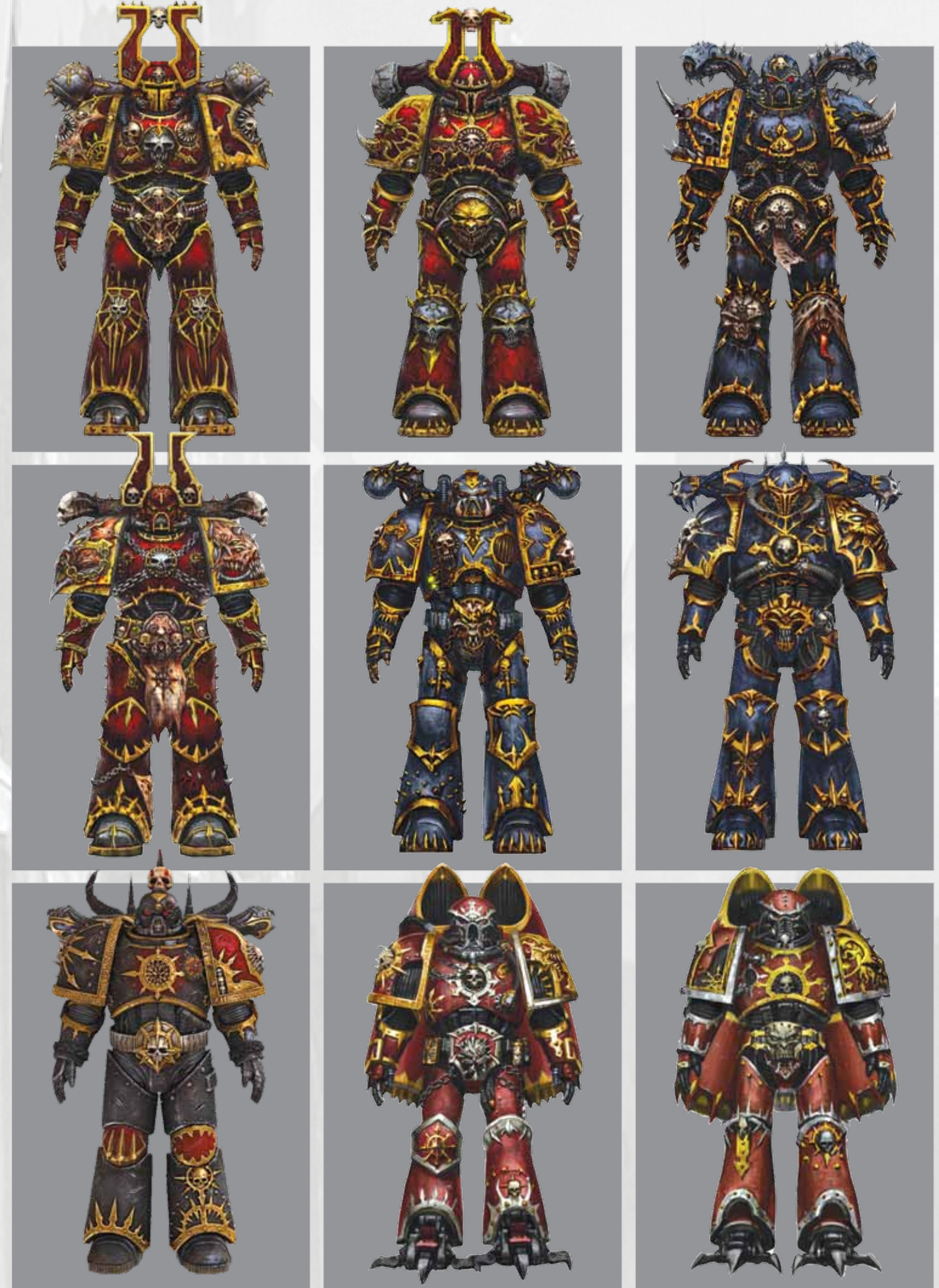



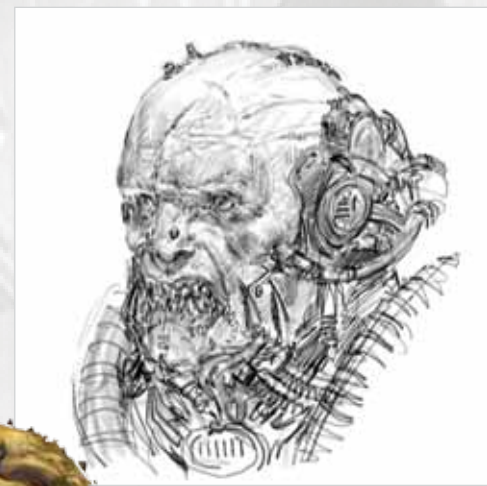
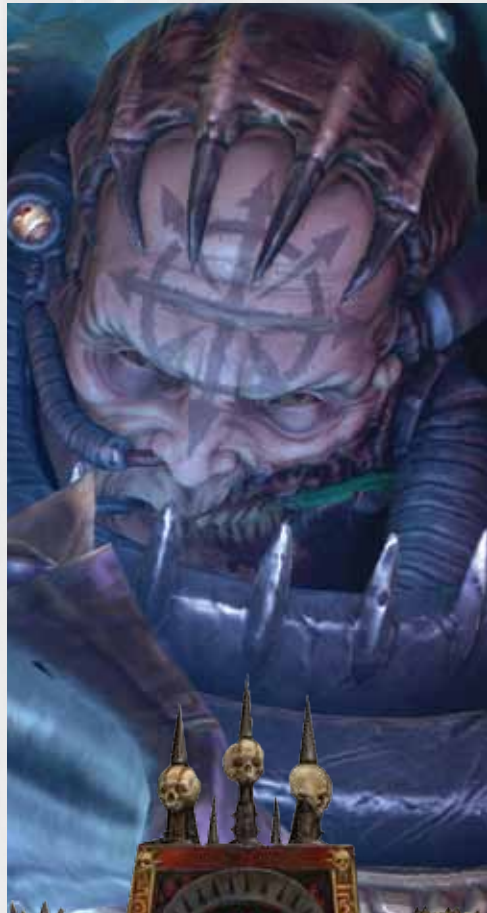



WARHAMMER
40,000

SPACE MARINE